

# Vertex Detector for GLD

Yasuhiro Sugimoto

KEK

16 Aug. 2005

@Snowmass

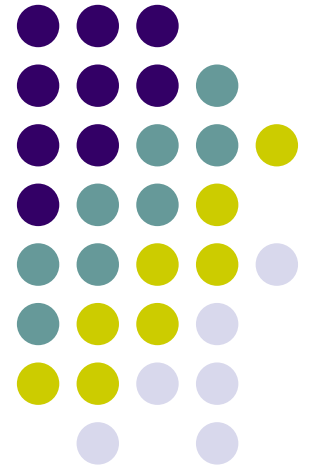

# Requirement for performance



- Role
  - Flavor tagging:  $\tau$ , c, b
    - Important for many physics analyses: e.g. Higgs branching ratio measurement
  - Quark/anti-quark tagging (Vertex charge measurement)

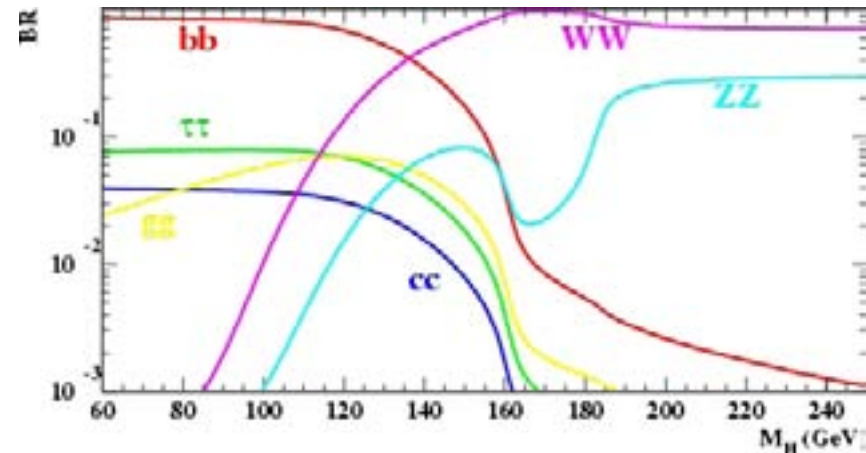

- Performance goal: Impact parameter resolution of  $\sigma = 5 \oplus \frac{10}{(p\beta \sin^{3/2}\theta)} \mu\text{m}$

This M.S. term demands R&D efforts:

- Very thin wafer/beam-pipe and support structure
- Put 1st layer close to the interaction point (high b.g.)

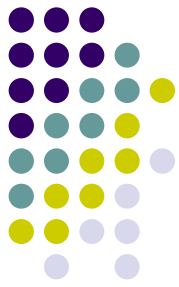

# Questions for optimization

- Sensor technology
- Inner / Outer radius
  - Background
  - Physics
- $\cos\theta$  coverage
  - Physics
  - Interface with FIT
- Support structure/Readout elec.
- Tracking efficiency v.s. background
- Effect of other PID devices (dE/dx, TOF etc.)
  - Flavor tag
  - Quark charge tag



# Sensor technology

- A lot of sensor technologies are proposed but none of them has been demonstrated to work at ILC
- For the moment, we assume “Fine Pixel” option as the baseline design of GLD because it is unique (different configuration from standard pixel options which are assumed in SiD and LDC)

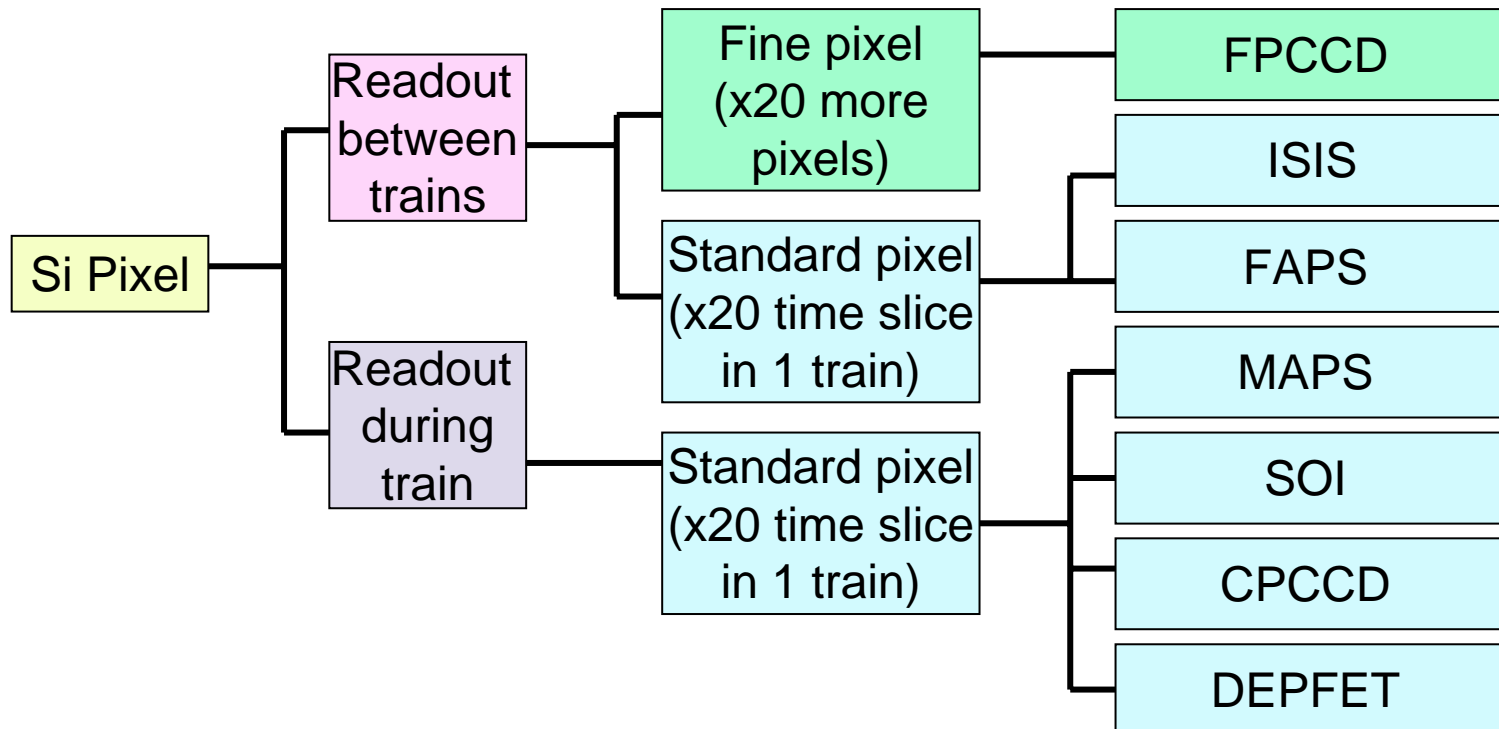

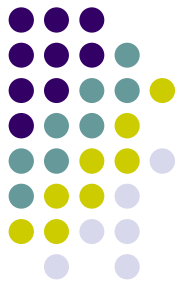

# Inner radius: Background

- Design criteria: Pair-background core should not hit the beam pipe
- B and Machine parameter dependence of  $R_{\text{VTX}}$  will be presented at the vertex sub-system working group session on 23ed and at the vertex session of GLD w.g. on 25th
- Baseline design should be compatible with the worst case

# Inner radius: Pair background

- Simulation by CAIN
- B-dependence  
(Track density: 1/cm<sup>2</sup>/BX)

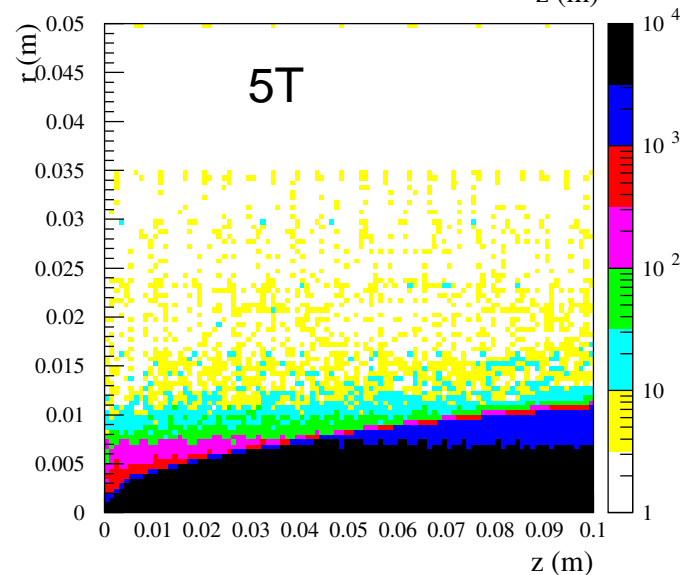
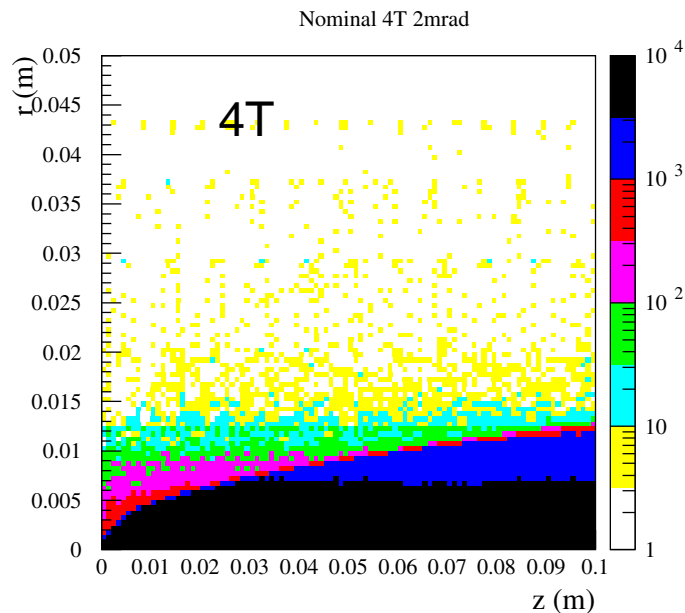
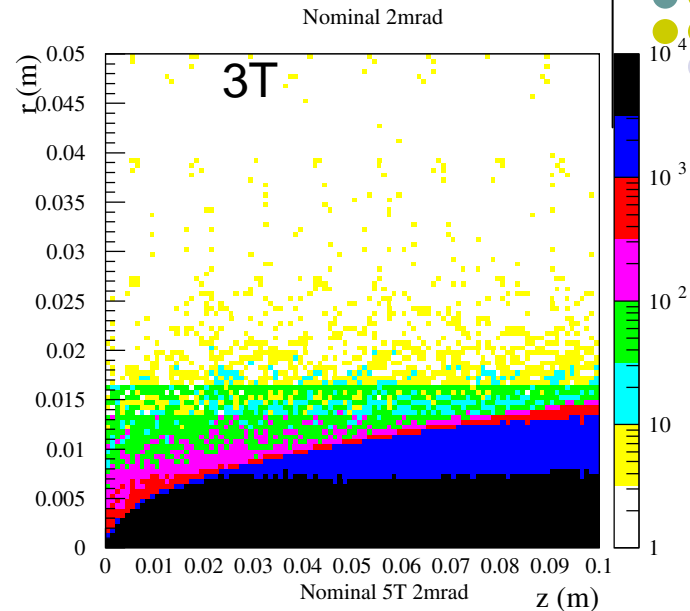

# Inner radius: Pair background

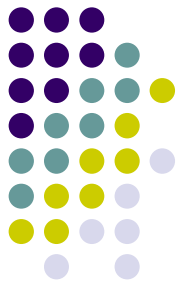

- Machine-option dependence (1)

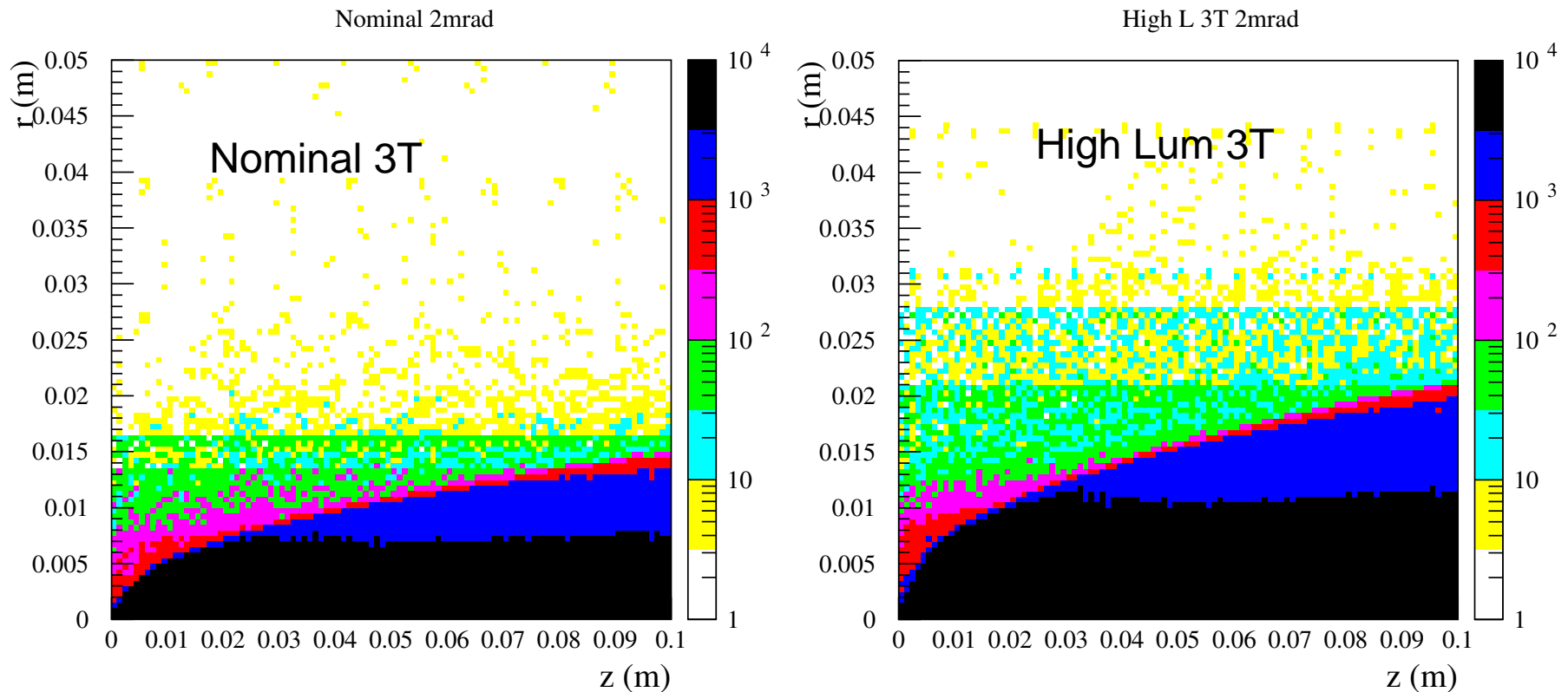

# Inner radius: Pair background

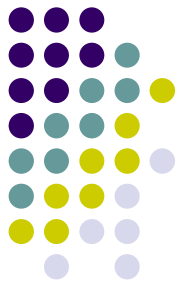

- Machine-option dependence (2)
  - Comparison of Tor's parameter and Andrei's parameter at 1TeV

Tor, 1TeV 3T

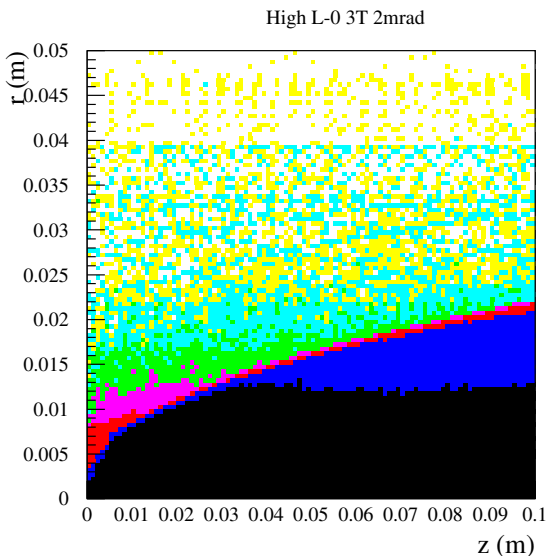

Andrei – I, 1TeV 3T

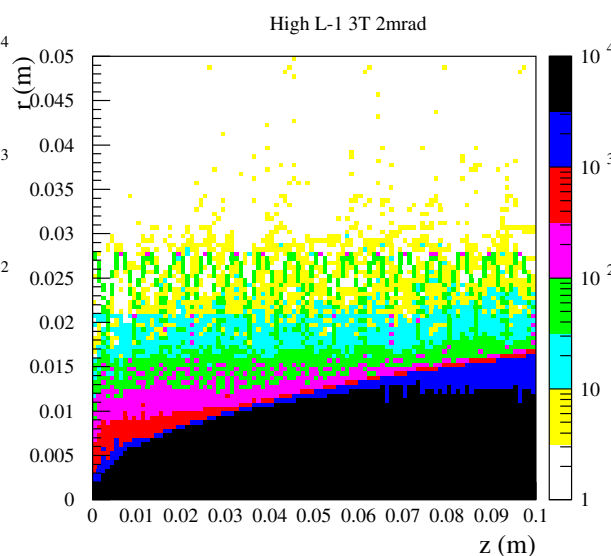

Andrei – II, 1TeV 3T

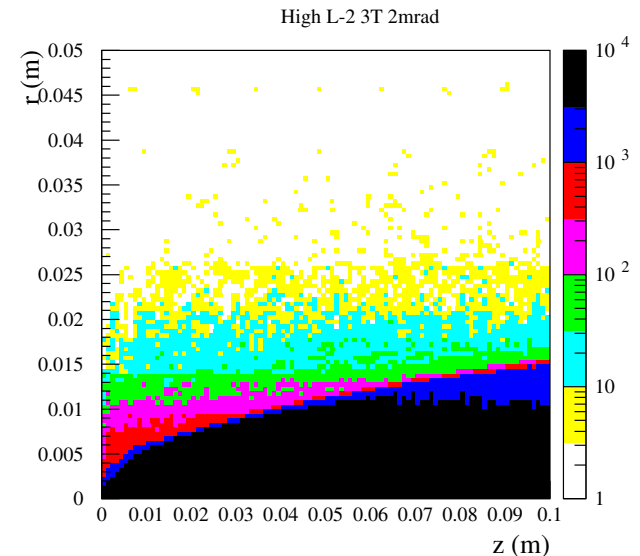



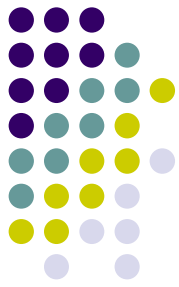

# Inner radius

- More to be considered:
  - Synchrotron radiation
    - $L^*$
    - Crossing angle
  - Back-scattering from BCAL
    - Hole size of low-Z mask
      - Synchrotron radiation
      - $L^*$ , Crossing angle
  - **Physics**

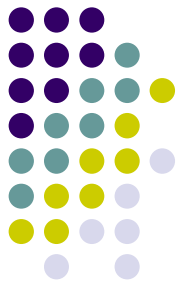

# Outer radius

- In GLD, outer radius of VTX is not crucial for the impact parameter resolution of high momentum tracks
  - High precision outer trackers (TPC and IT) works as “outer layer” of the vertex detector
  - VTX layer configuration should be determined from the view point of;
    - Track finding under high background rate
    - Impact parameter resolution for low momentum tracks

# Tracking efficiency v.s. B.G.



- Disadvantage of Fine Pixel option:
  - High hit density:  $\sim 40/\text{mm}^2/\text{train}$  at  $R=20\text{mm}$ ,  $B=3\text{T}$ , nominal option at  $500\text{ GeV}$
  - Background hit can cause wrong-track finding

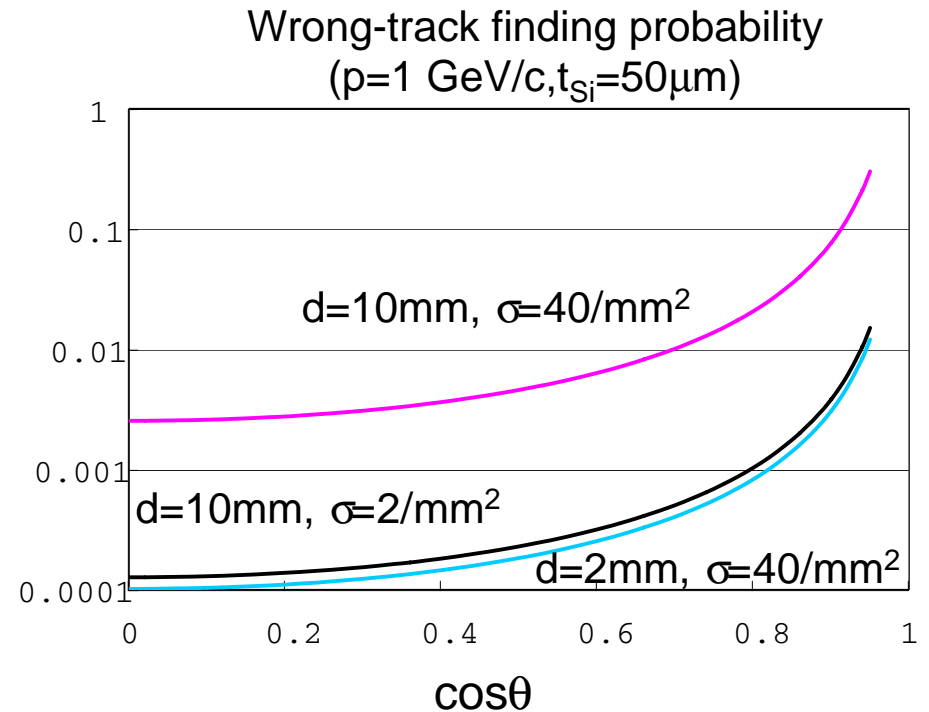
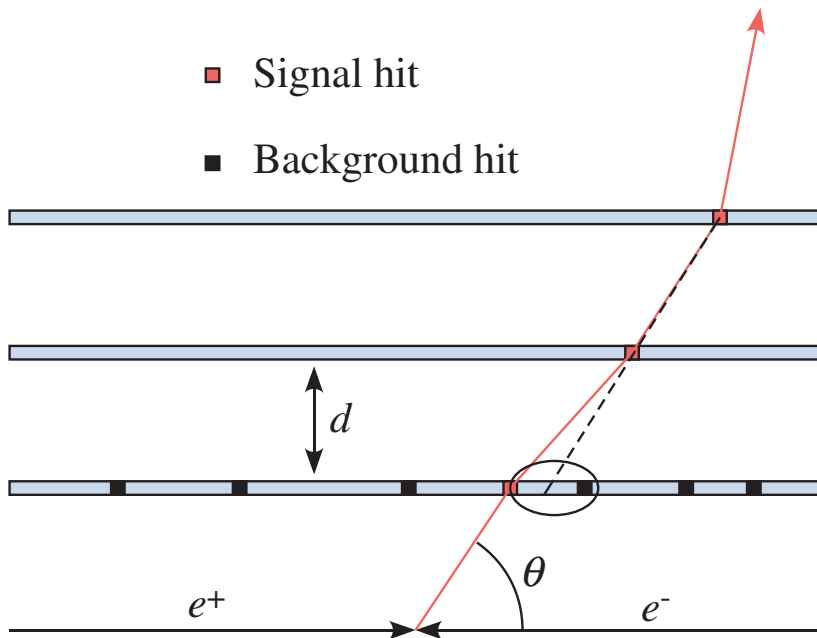



# Tracking efficiency v.s. B.G.

- Advantage of Fine Pixel option
  - Fine segmentation enables background rejection using hit cluster shape

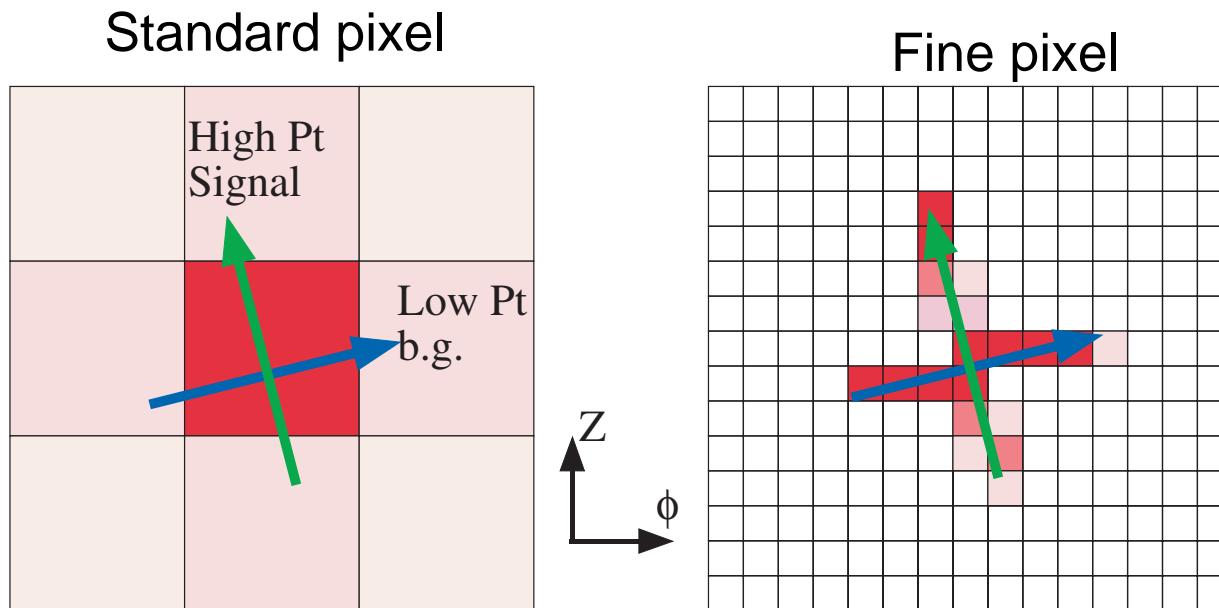

(tracking capability with single layer!)

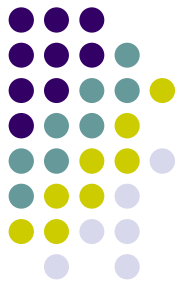

# B.G. rejection by cluster shape

$$dW = \sqrt{(WZ_{BG} - WZ_{Sig})^2 + (W\phi_{BG} - W\phi_{Sig})^2}$$

$WZ_{Sig}$ ,  $W\phi_{Sig}$ : Expected width

- $dW \sim 0$  for high  $p_t$  signal tracks but large for pair background tracks

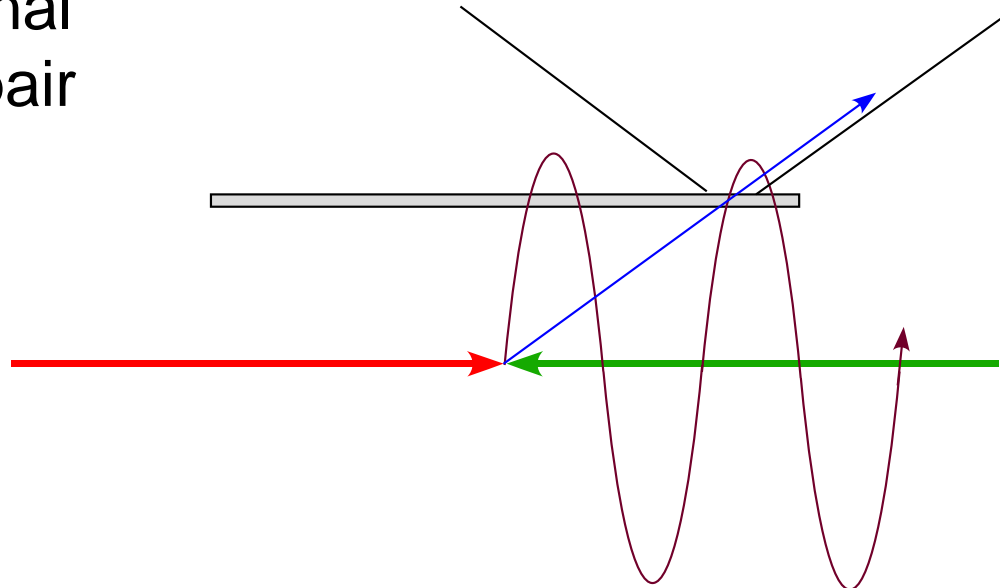
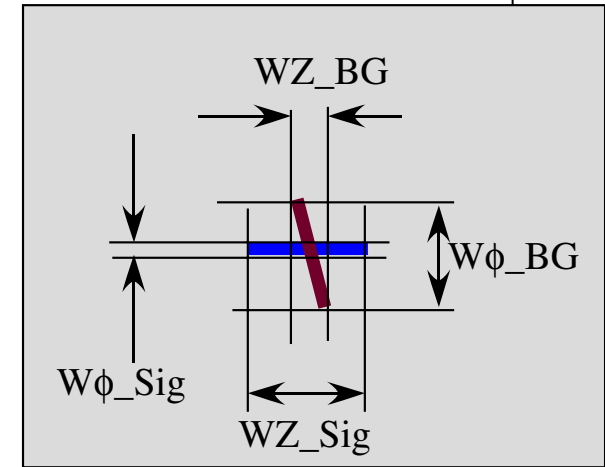

# B.G. rejection by cluster shape



- dW v.s. z for pair b.g.

- 500 GeV
- 100 BX
- R=20 mm

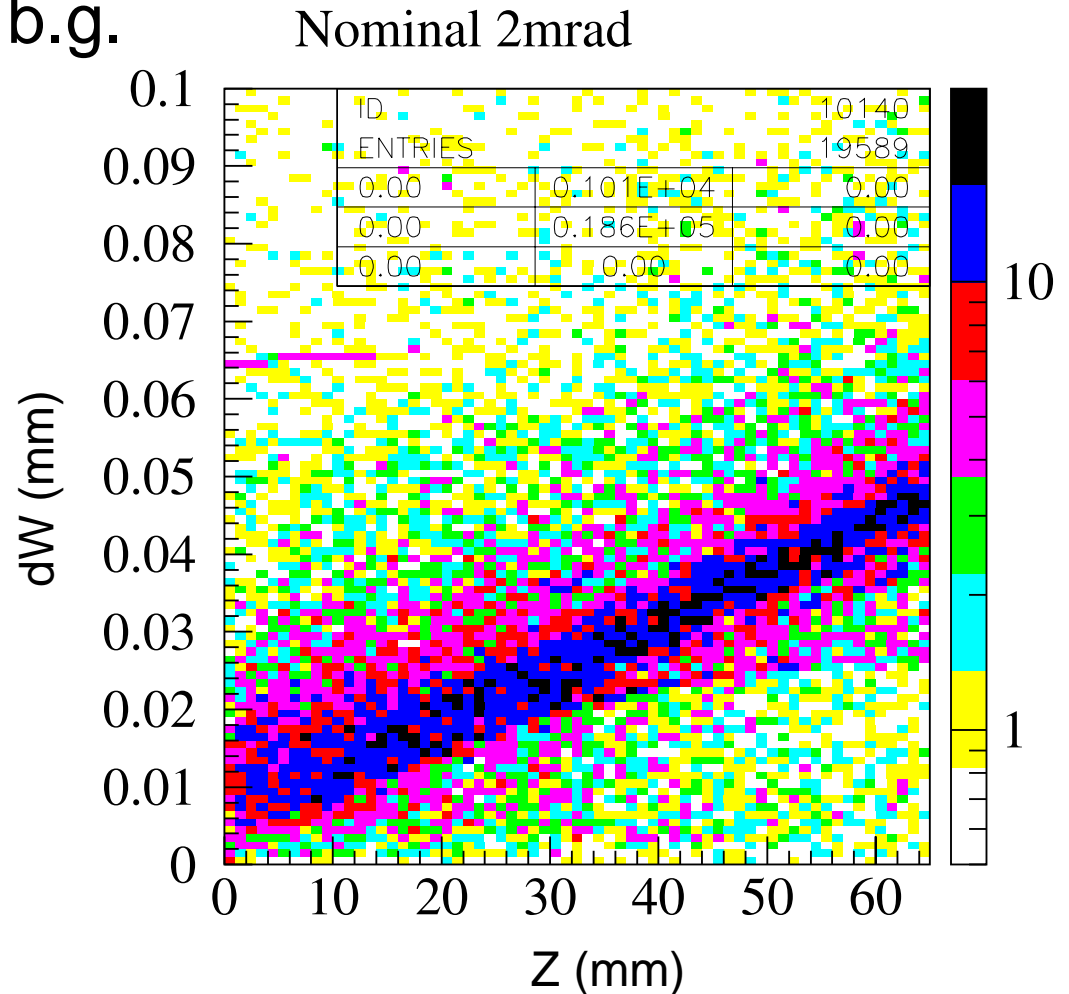

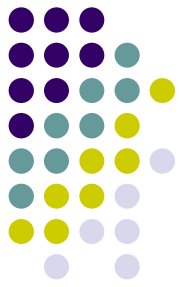

# B.G. rejection by cluster shape

- R=20mm
- Cut at  $dW=10\mu\text{m}$

Nominal 2mrad

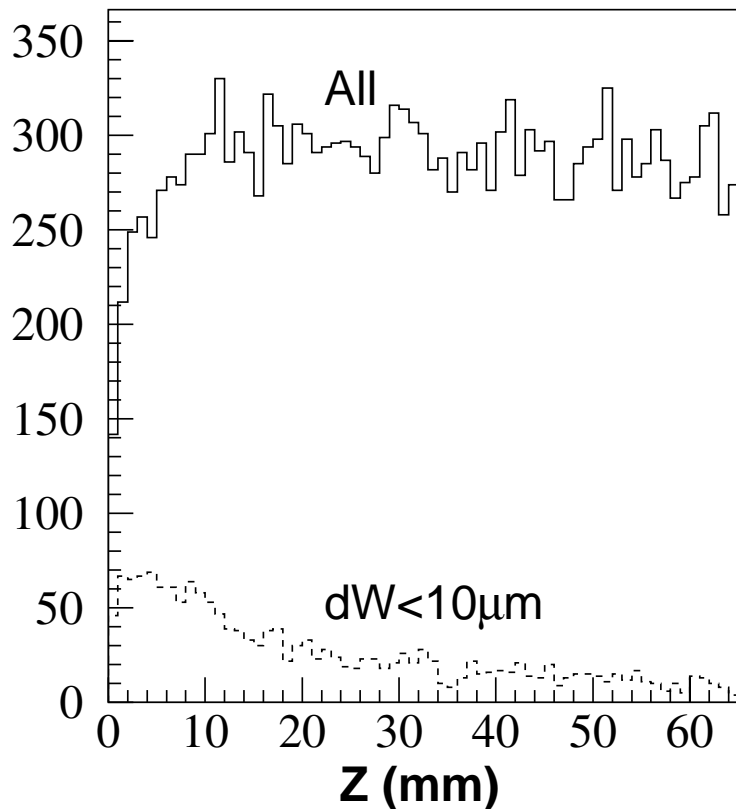

Nominal 2mrad

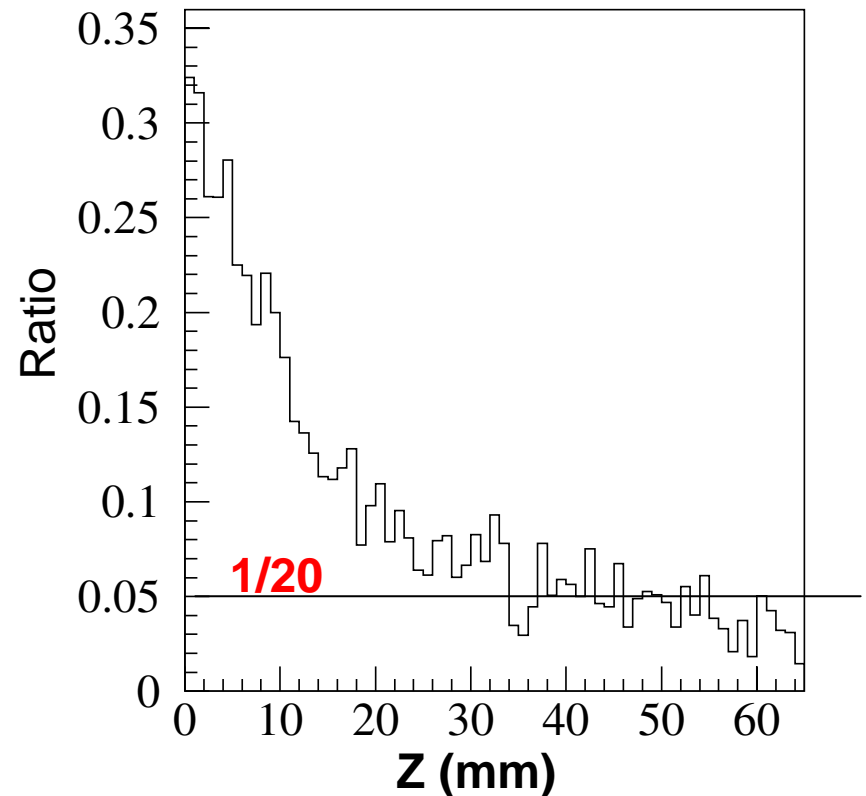

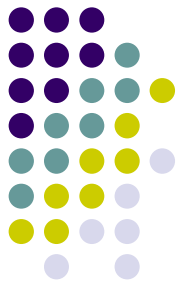

# B.G. rejection by cluster shape

- Detector full simulation
  - $N_z > Z(\text{cm}) \times 1.2$ ,  $N_x < 3$

Efficiency for pair b.g.

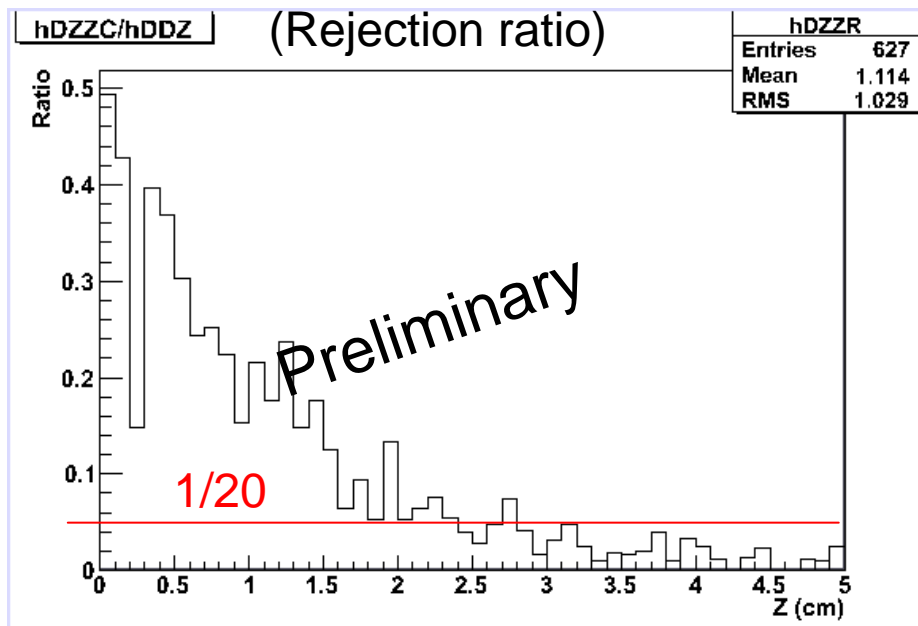

Efficiency for 1 GeV/c muon

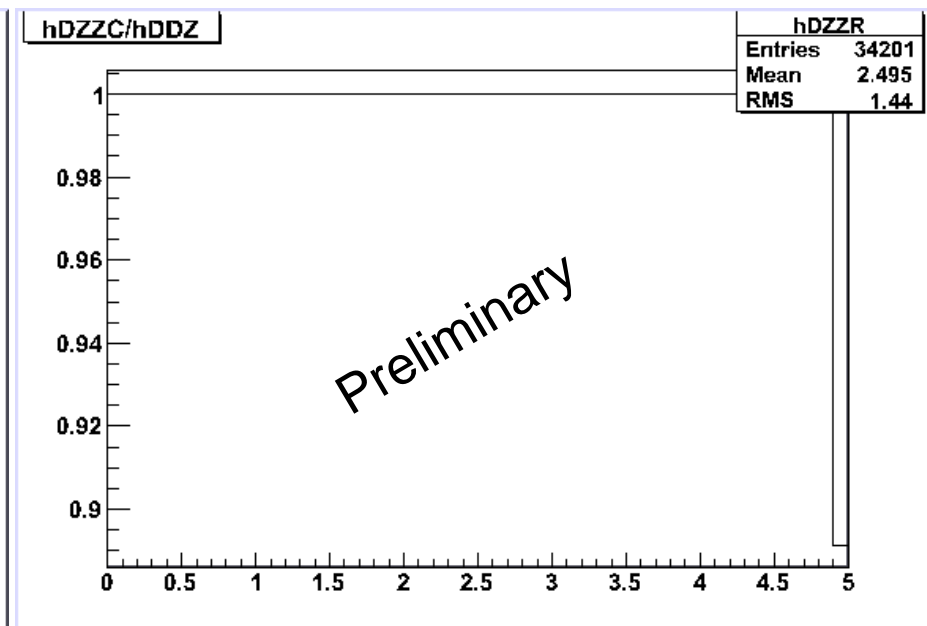



# Tentative baseline design

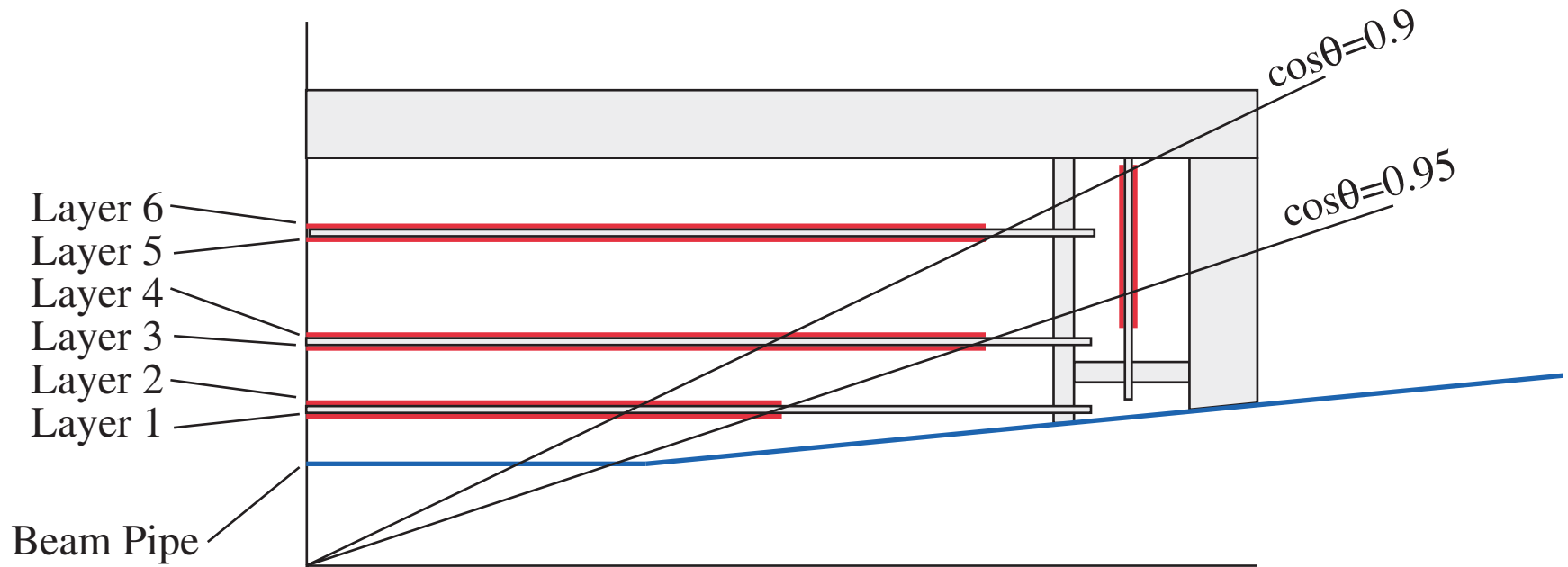

# Summary



- We assume Fine Pixel option as the baseline design for the GLD vertex detector
  - Inner radius depends on the pair background. The distribution of the pair background has a large dependence on the machine parameter
  - The high hit density of Fine Pixel option can be overcome by background rejection using cluster shape
  - More optimization study is necessary based on
    - New high luminosity parameter at 500 GeV
    - Synchrotron radiation
    - Backscattering from BCAL
    - Interface with FIT
    - Physics
- as much as possible in this workshop

# Backup slides





# Advantages of FPCCD

- Free from beam-induced RF noise
- $\sigma_x \sim 1.4\mu\text{m}$  even with digital readout
- Simple structure : advantageous for large size
- Active circuit on one edge : easy to control temperature
- Readout speed: 15MHz is enough  
( $128(V) \times 20000(H) / 200\text{ms} = 12.8\text{MHz}$ )

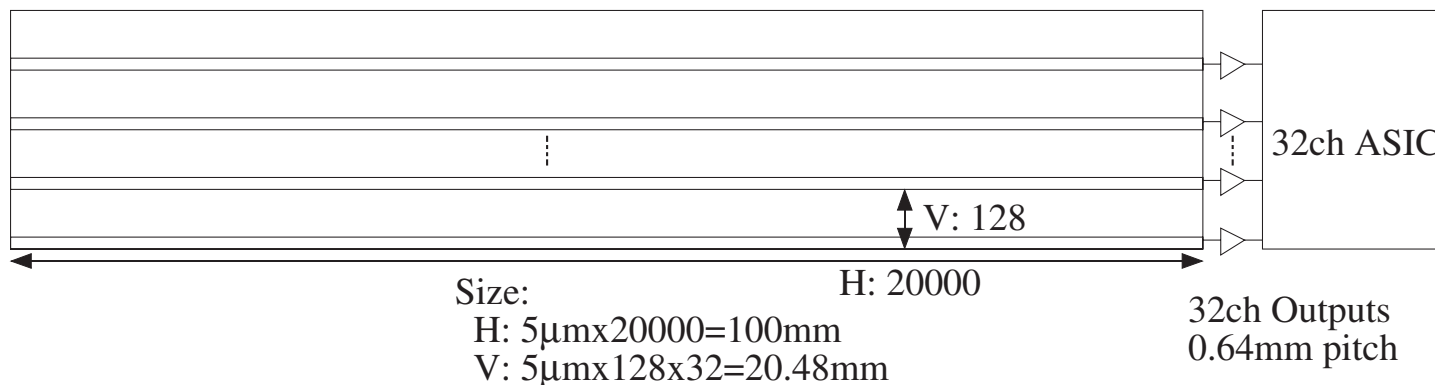
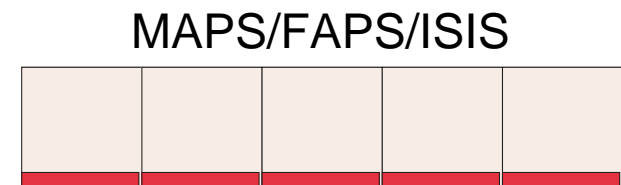
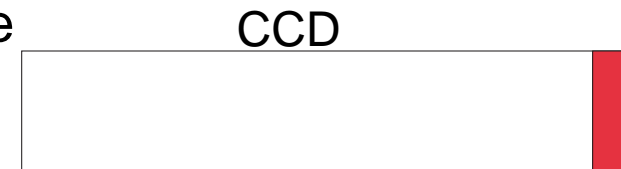

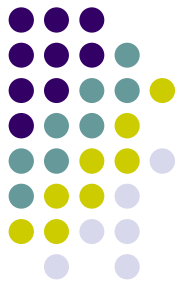

# Impact parameter resolution

- Full simulation study by Jupiter
- Parameters:
  - Old standard option:
    - $R=24, 36, 48, 60$  mm
    - $t = 330 \mu\text{m}/\text{layer}$
    - $\sigma = 4 \mu\text{m}$
  - FPCCD option:
    - $R=20, 22, 39, 41, 58, 60$  mm
    - $t = 80 \mu\text{m}/\text{layer}$
    - $\sigma = 2 \mu\text{m}$
  - Be beam pipe (common):
    - $R=18$  mm
    - $t = 500 \mu\text{m}$

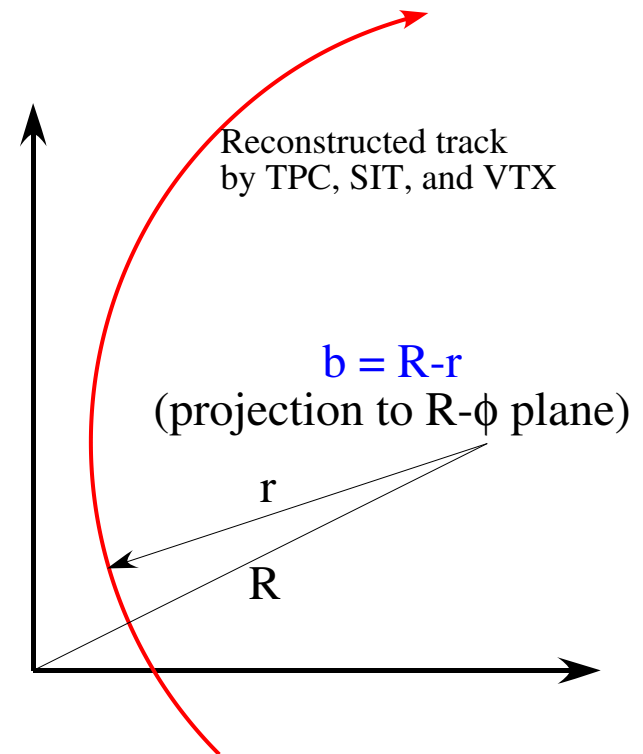

# Impact parameter resolution

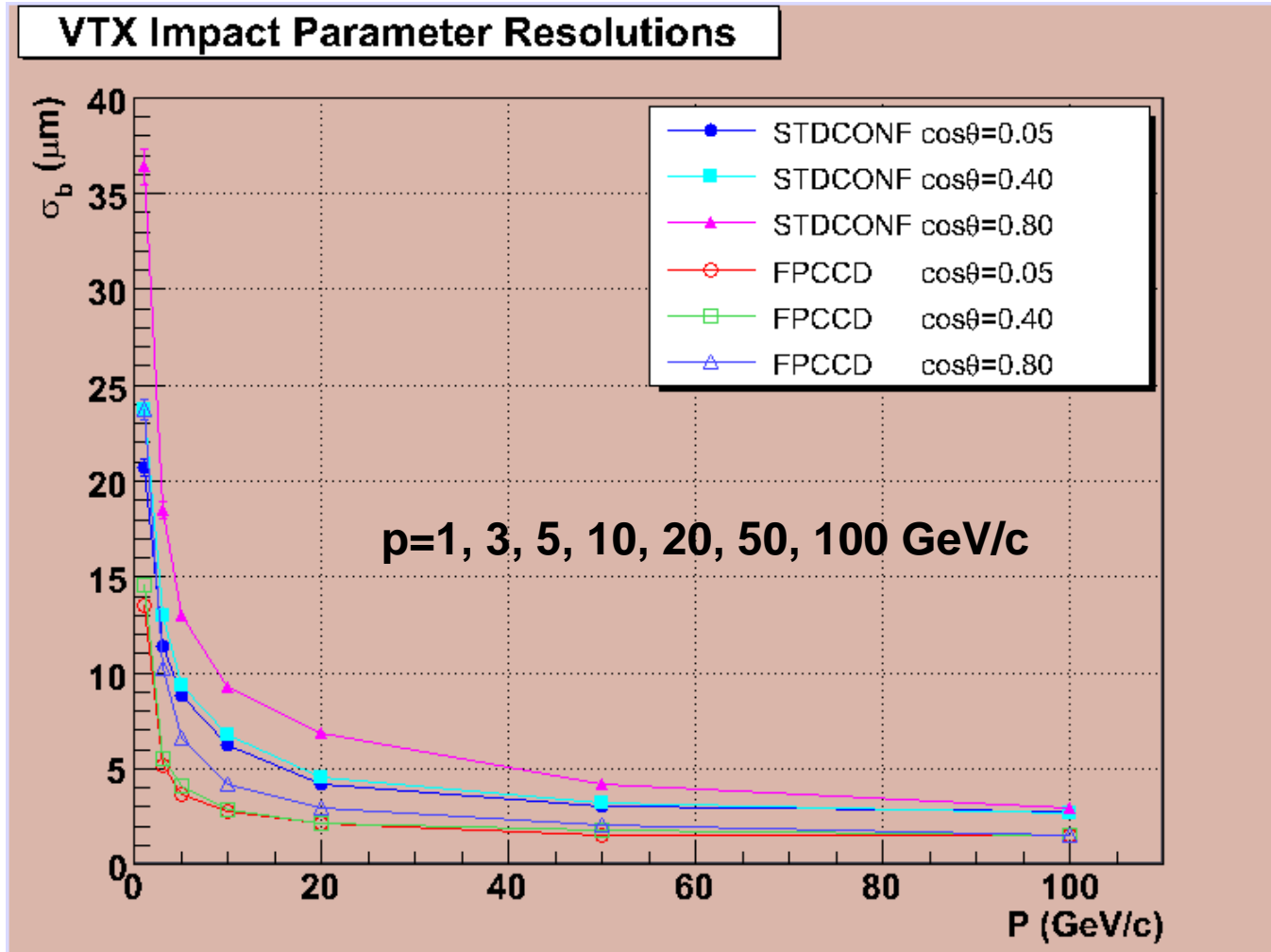

# Lorentz angle

- Lorentz angle in depleted-layer
  - $\tan\theta = \mu_n B$   
 $\mu_n$ : electron mobility
  - Carrier velocity saturates at high E field:
    - $\mu_n = 0.07 \text{ m}^2/\text{Vs}$   
 @  $T=300\text{K}$ ,  $E=1 \times 10^4 \text{ V/cm}$
    - $\mu_n = 0.045 \text{ m}^2/\text{Vs}$   
 @  $T=300\text{K}$ ,  $E=2 \times 10^4 \text{ V/cm}$
  - Small angle can be cancelled by tilting the wafer
- May not be a serious problem
  - Number of hit pixels does not increase so much

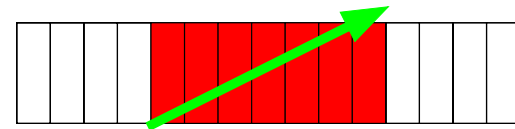
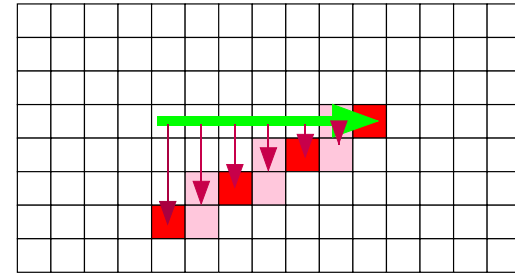

	B=3T	B=5T
E=1x10 <sup>4</sup> V/cm	θ=12deg	θ=19deg
E=2x10 <sup>4</sup> V/cm	θ=7.7deg	θ=13deg

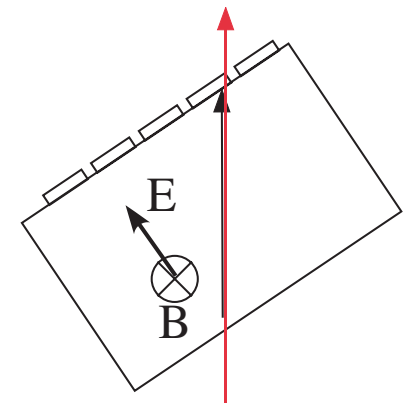
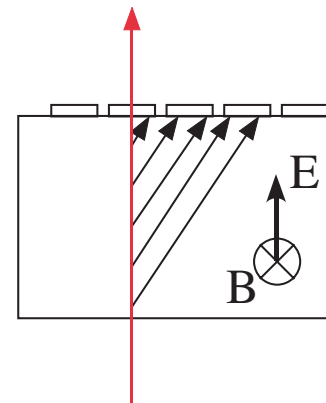

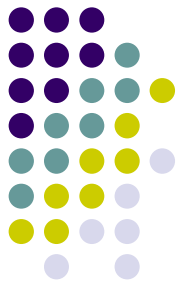

# Lorentz angle

- Calculation of E-field in epi-layer
  - Tools
    - FEMLAB (COMSOL in Japan) 3.1
    - Solve Poisson equation by finite element analysis (FEA)
  - Parameters
    - Material is assumed fully depleted (No free charge)
    - n-layer:  $N_D=1 \times 10^{16}/\text{cm}^3=1.6 \times 10^3 \text{ C/m}^3$
    - Epi-layer:  $N_A=1 \times 10^{13}/\text{cm}^3=-1.6 \text{ C/m}^3$
    - $V_G=4 \text{ V}$
    - $t_{\text{SiO}_2}=100 \text{ nm}$
    - $t_n=1 \text{ }\mu\text{m}$
    - $t_{\text{epi}}=15 \text{ }\mu\text{m}$



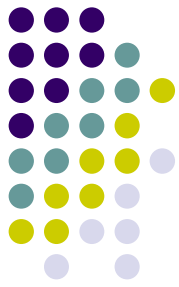

# Lorentz angle

- Result of E-field calculation

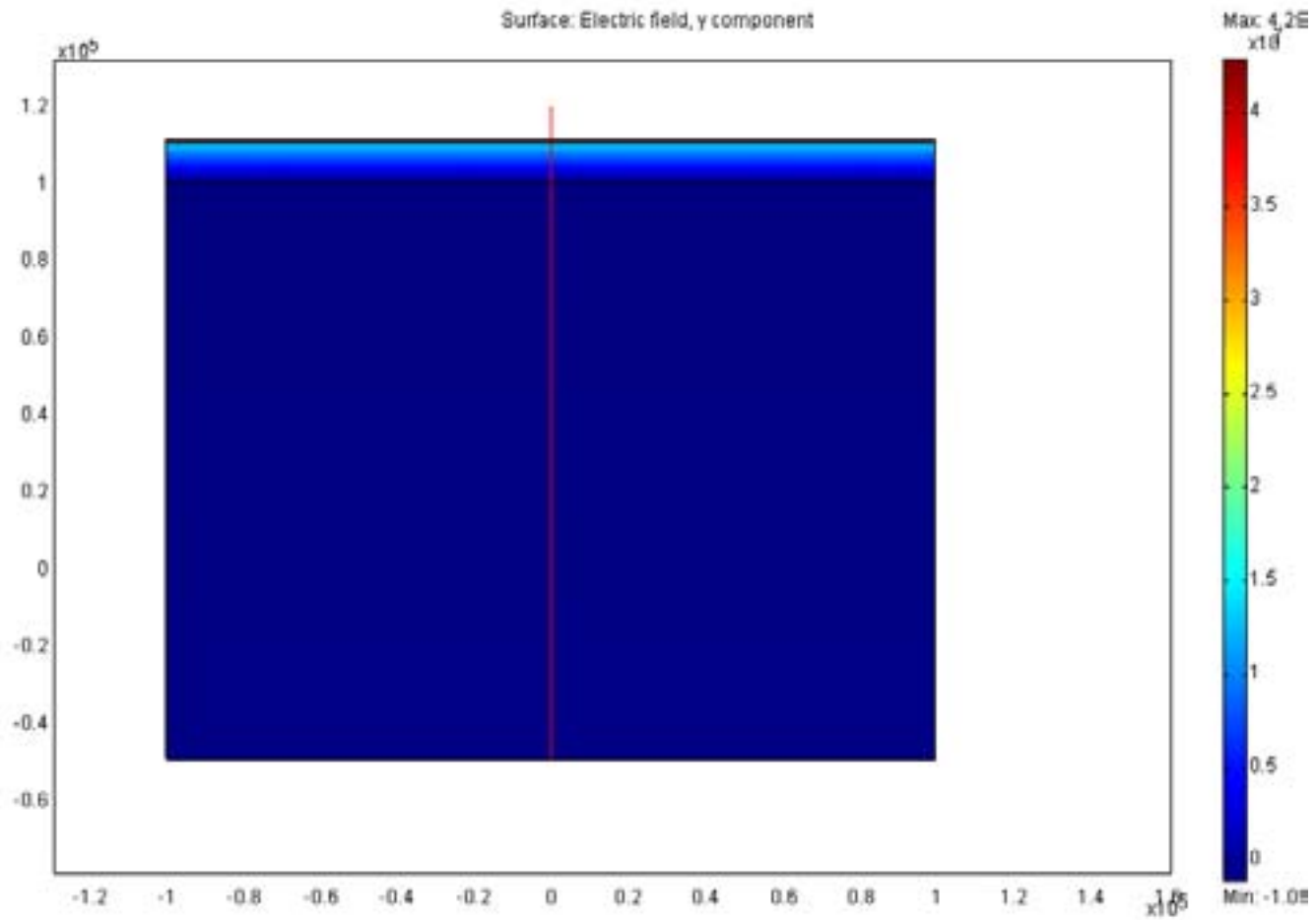

# Lorentz angle



- Result of E-field calculation – Potential

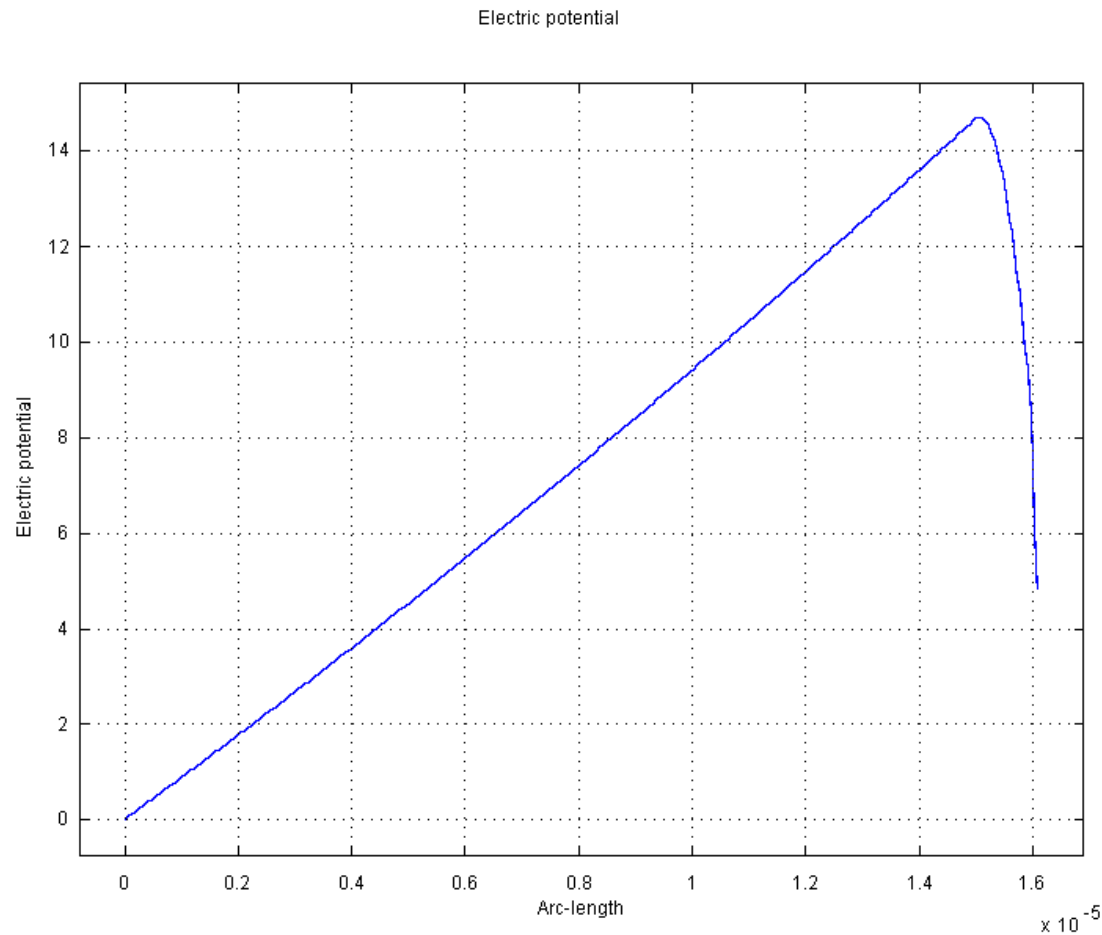

# Lorentz angle



- Result of E-field calculation – Summary
  - Almost constant E-field of  $\sim 10^4$  V/cm in epi-layer can be achieved
  - E-field in epi-layer depends on gate voltage
    - Higher (positive) gate voltage gives higher E-field
    - Positive gate voltage should be applied during train crossing in order to get saturated carrier velocity and less Lorentz angle (Inverted (MPP) mode can be maintained for  $\sim 1$  ms)
  - The Lorentz angle of 12 degrees is expected at  $B=3$  T