

July 22, '99

# **Analysis on support tube (very preliminary)**

KEK Hiroshi Yamaoka

## **Contents**

- 1. Introduction**
- 2. Static Analysis**
- 3. Natural Frequency**
- 4. Spectrum Analysis**

# 1. Introduction

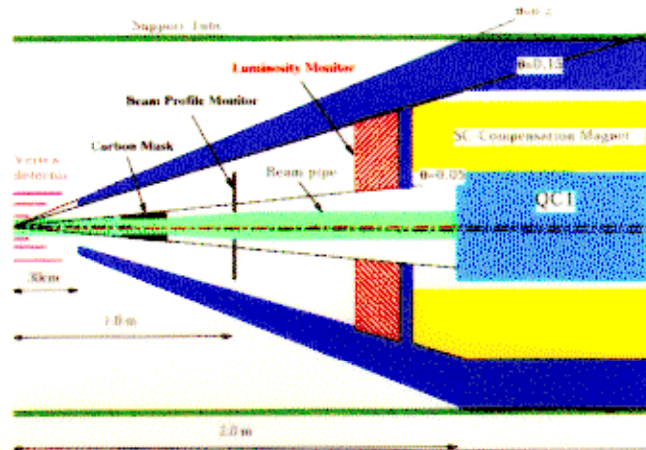
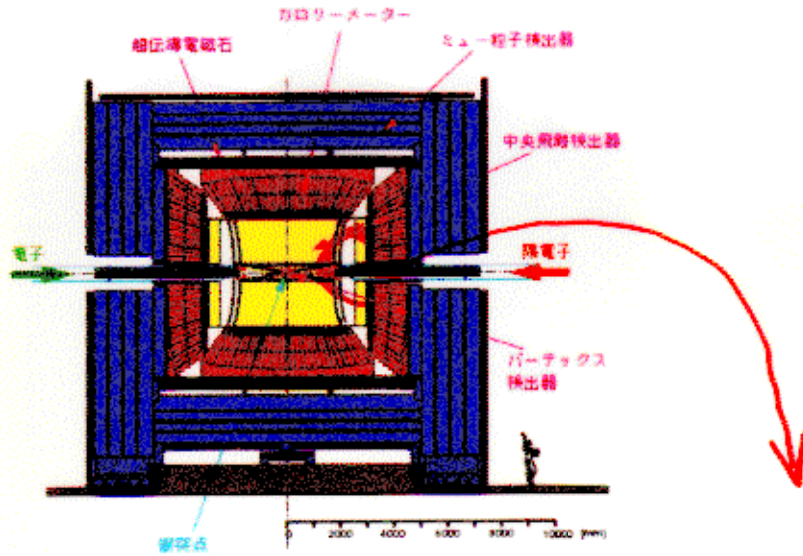

## Assumption

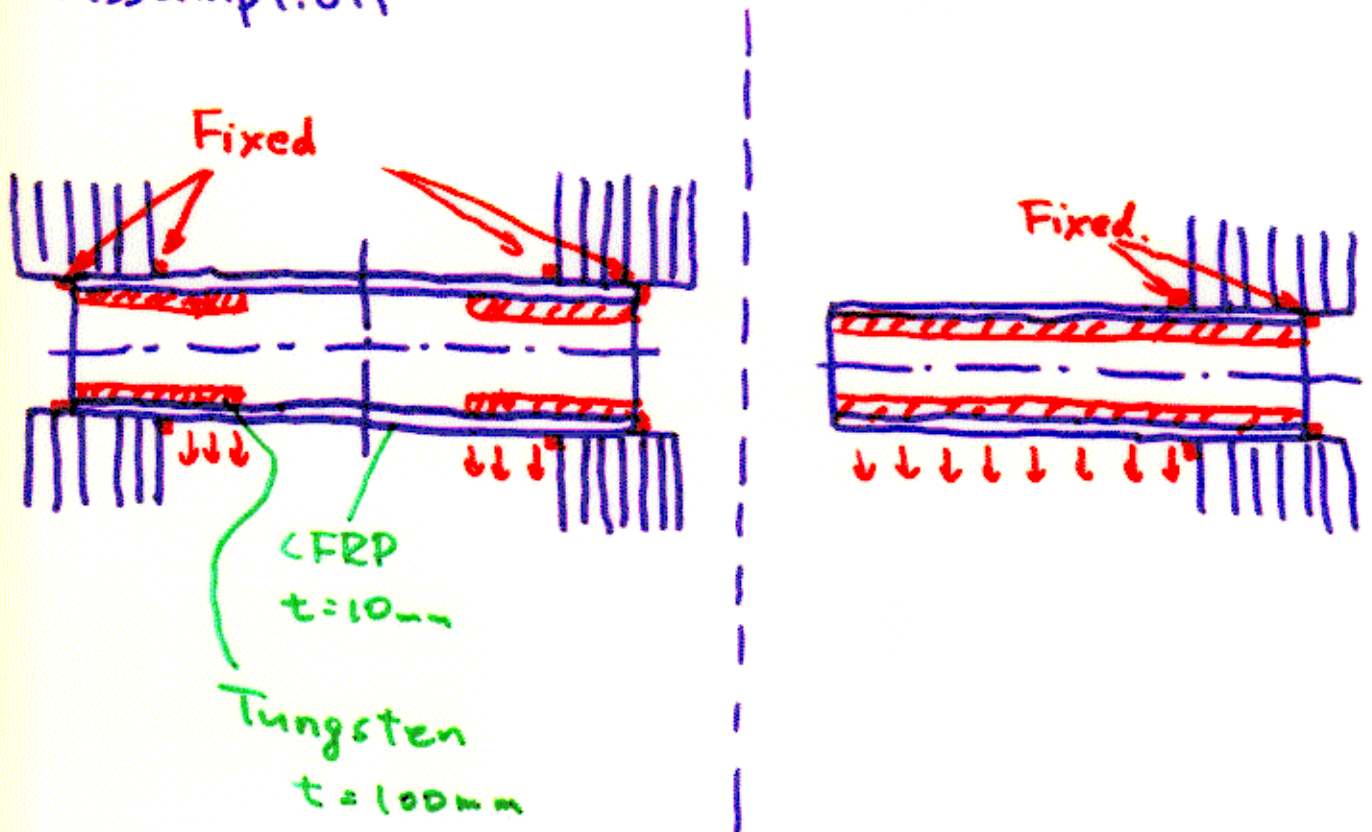

## 2. Static Analysis

(1)-a Simply supported at both ends

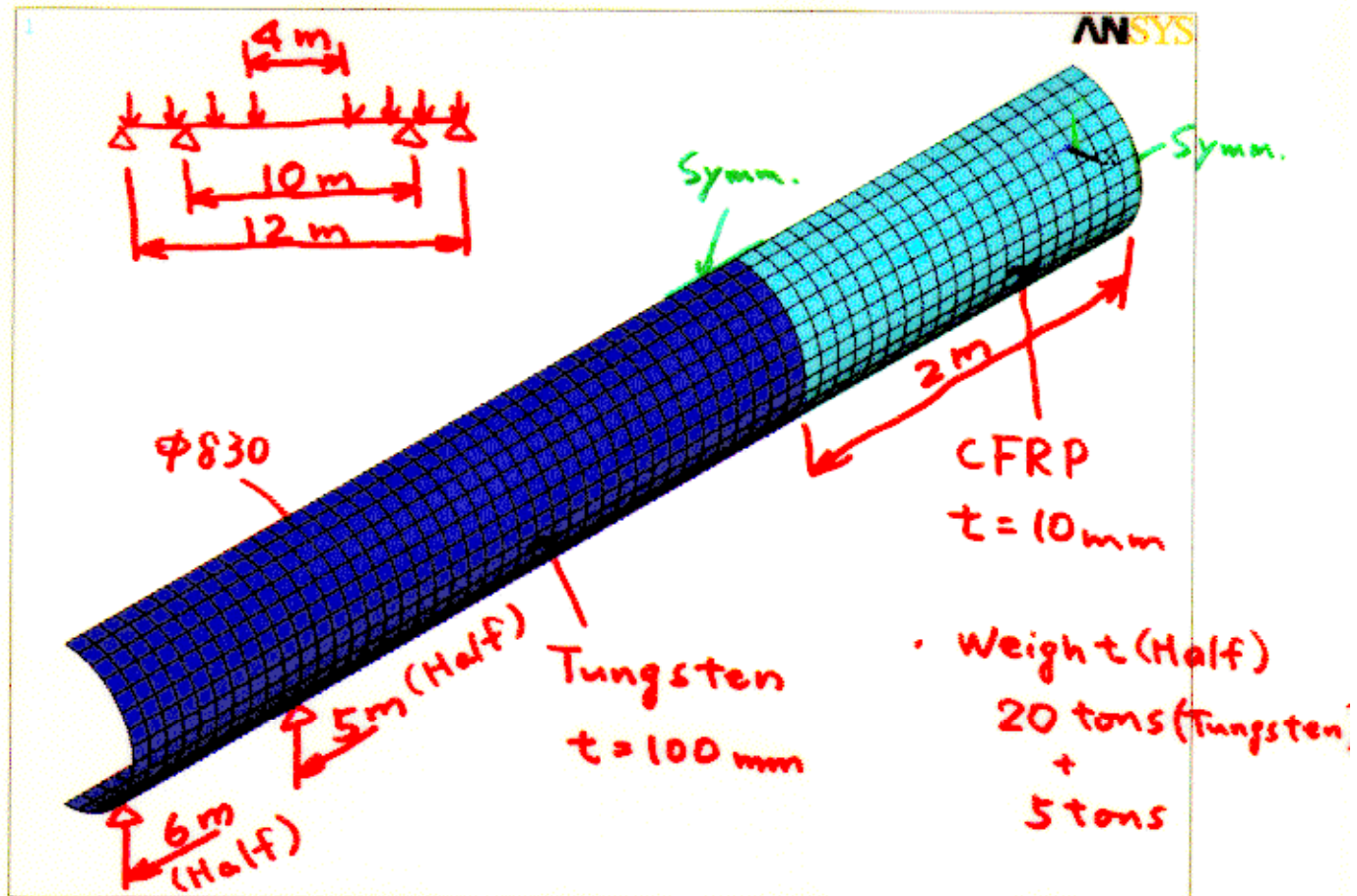

### ○ CFRP

Young's modulus:  $1.5 \times 10^4 \text{ kg/mm}^2$  (150 GPa)

Density :  $1.5 \times 10^{-6} \text{ kg/mm}^2$

### ○ Tungsten

Young's modulus:  $4.15 \times 10^4 \text{ kg/mm}^2$  (415 GPa)

Density :  $19.3 \times 10^{-6} \text{ kg/mm}^2$

!! Rigidity of Tungsten is taking account.

$$D = E_T \cdot I_T \text{ (Tungsten)} + E_C \cdot I_C \text{ (CFRP)} \quad I = \frac{\pi(d_o^4 - d_i^4)}{64}$$



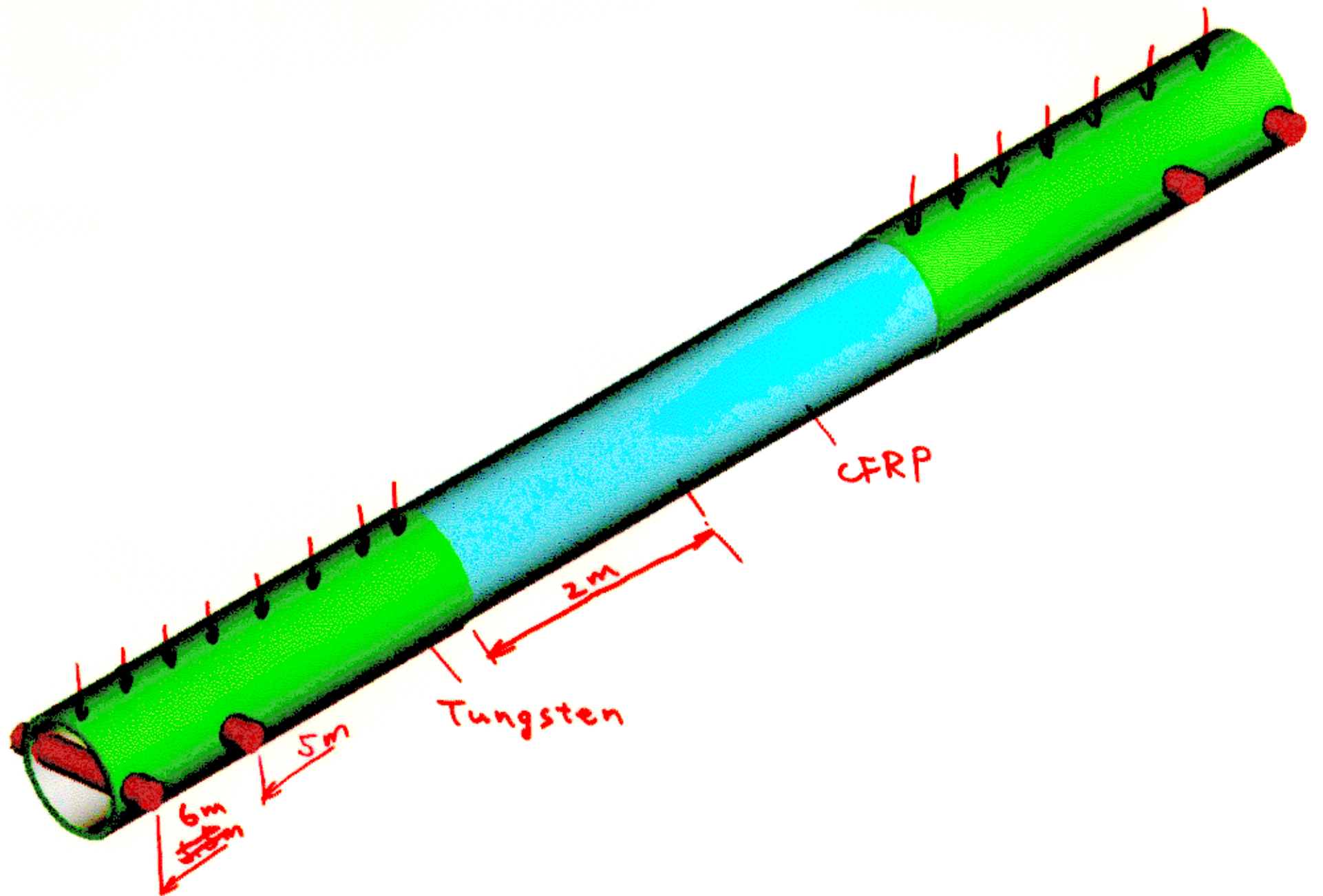

# (1)-b Results

Deformation

ANSYS JUL 18 1999  
13:19:06

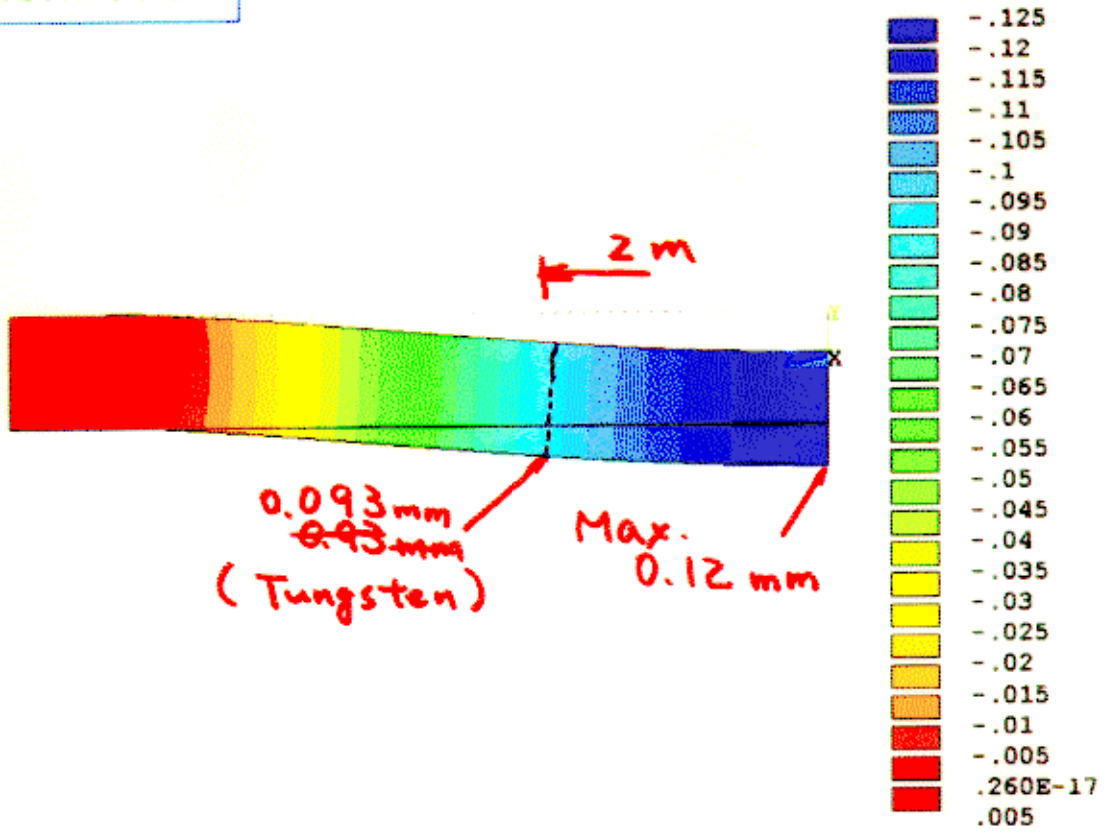

Stress

ANSYS JUL 18 1999  
13:50:29

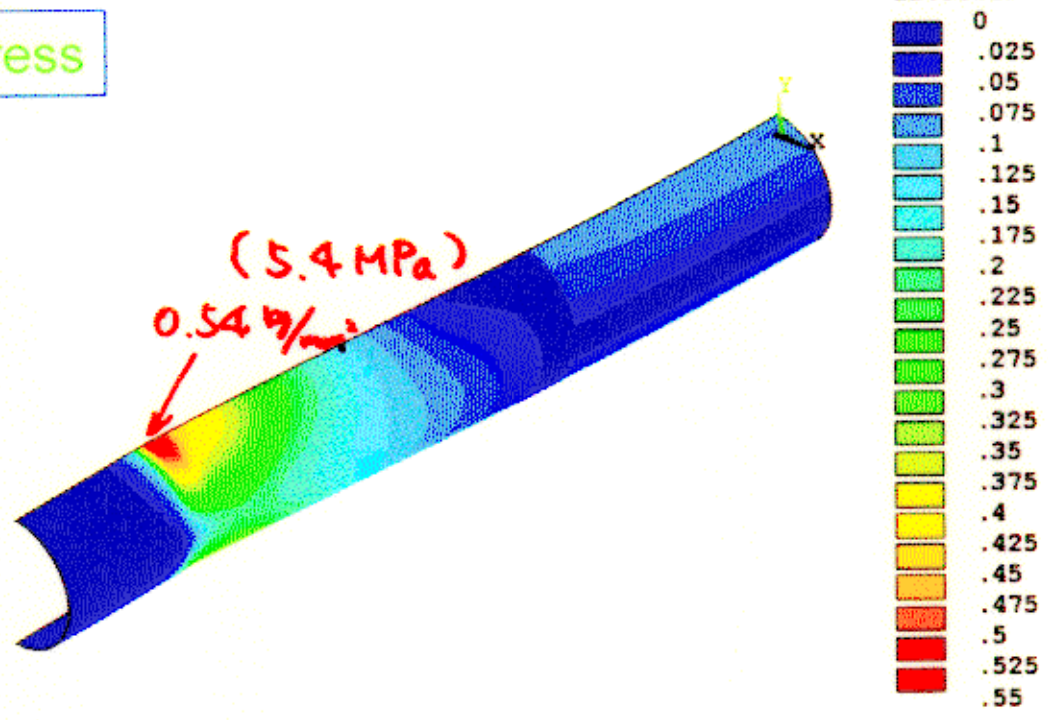

## (2)-a Supported at one end(Cantilever)

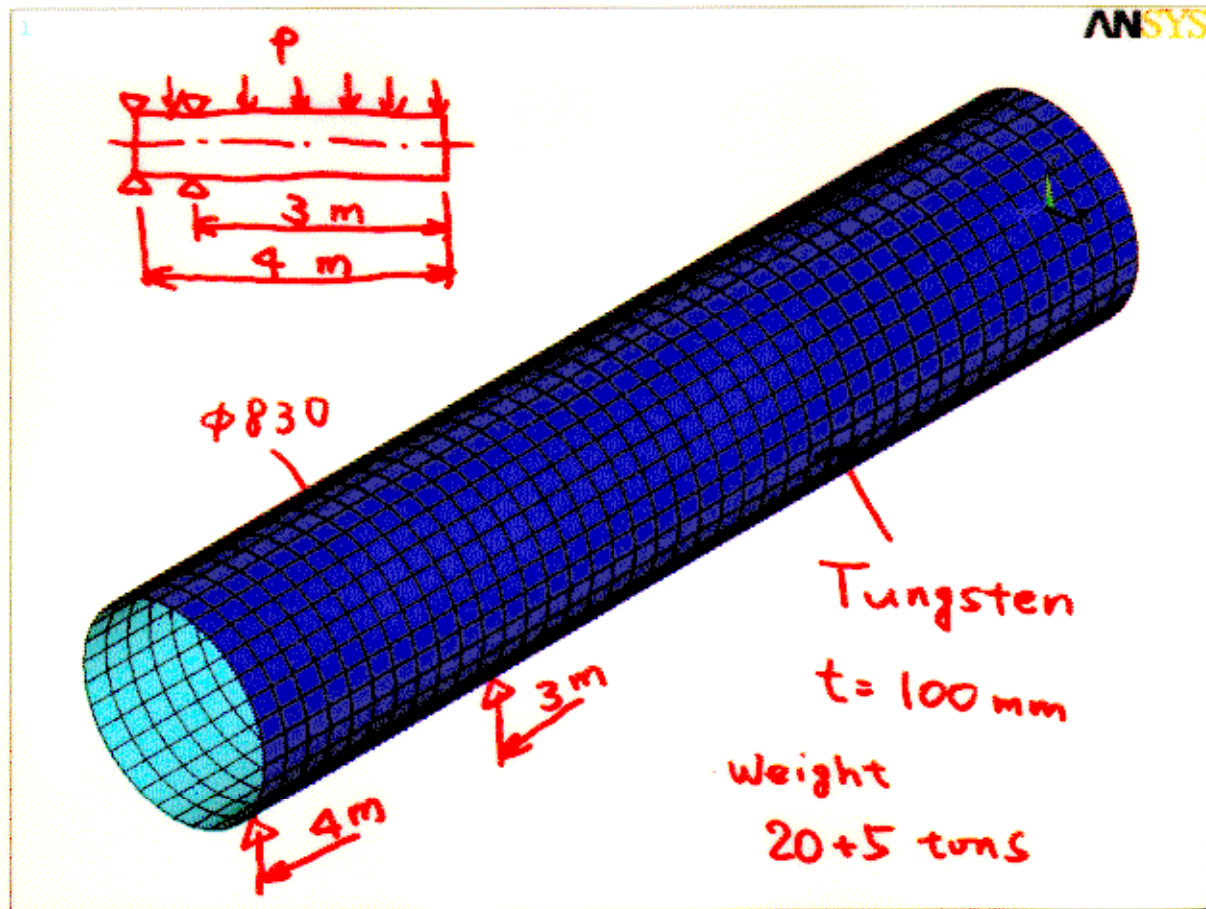

### O Tungsten

Young's modulus:  $4.15 \times 10^4 \text{ kg/mm}^2$  (415 GPa)

Density :  $19.3 \times 10^{-6} \text{ kg/mm}^2$

!! Rigidity of Tungsten mask is taking account.



## (2)-b Results

ANSYS

JUL 18 1999  
13:36:24

Deformation

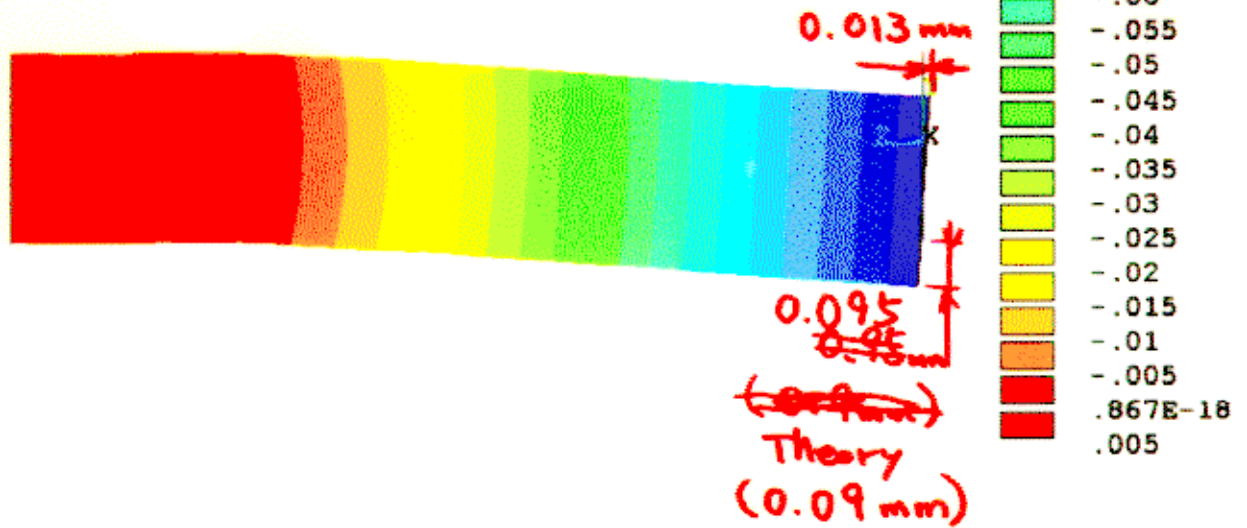

ANSYS

JUL 18 1999  
13:42:12

Stress

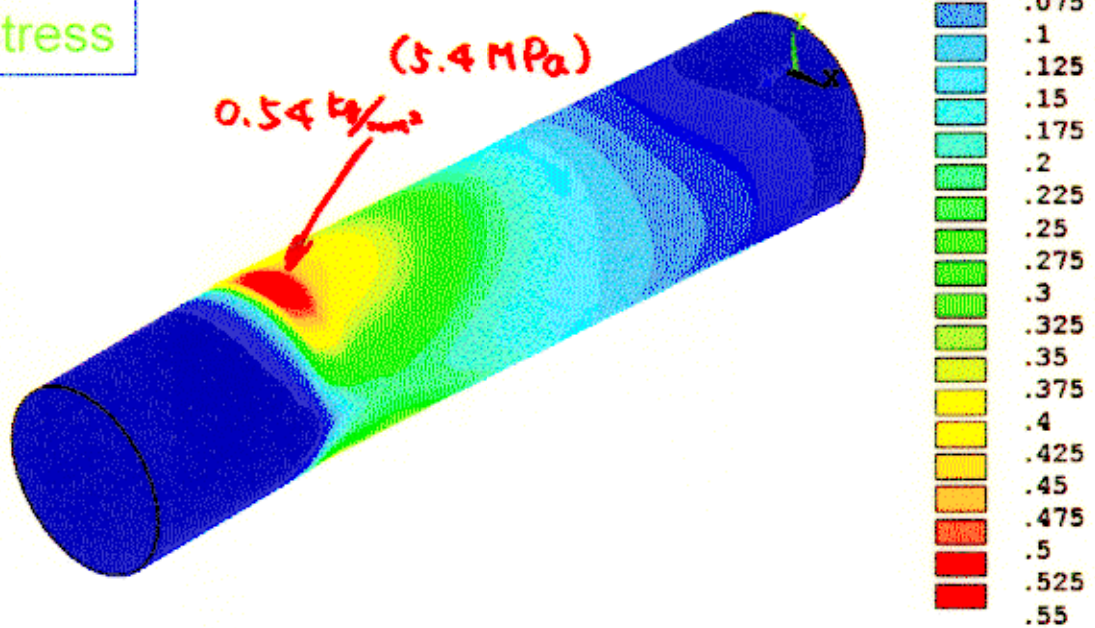

### (3) No rigidity of the Tungsten mask

(3)-a Both ends simply fixed.

$$D = \frac{E_T \cdot I_T}{E_c \cdot I_c} (\text{Tungsten}) + E_c \cdot I_c (\text{CFRP})$$

ANSYS JUL 18 1999  
13:57:52

Deformation

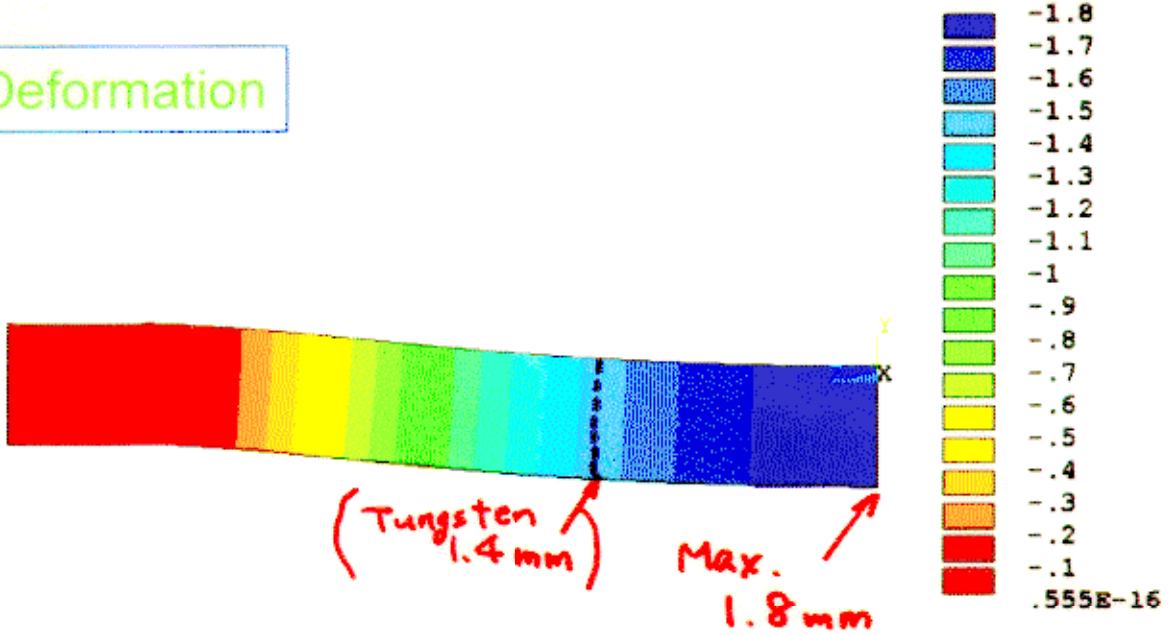

ANSYS JUL 18 1999  
13:59:48

Stress

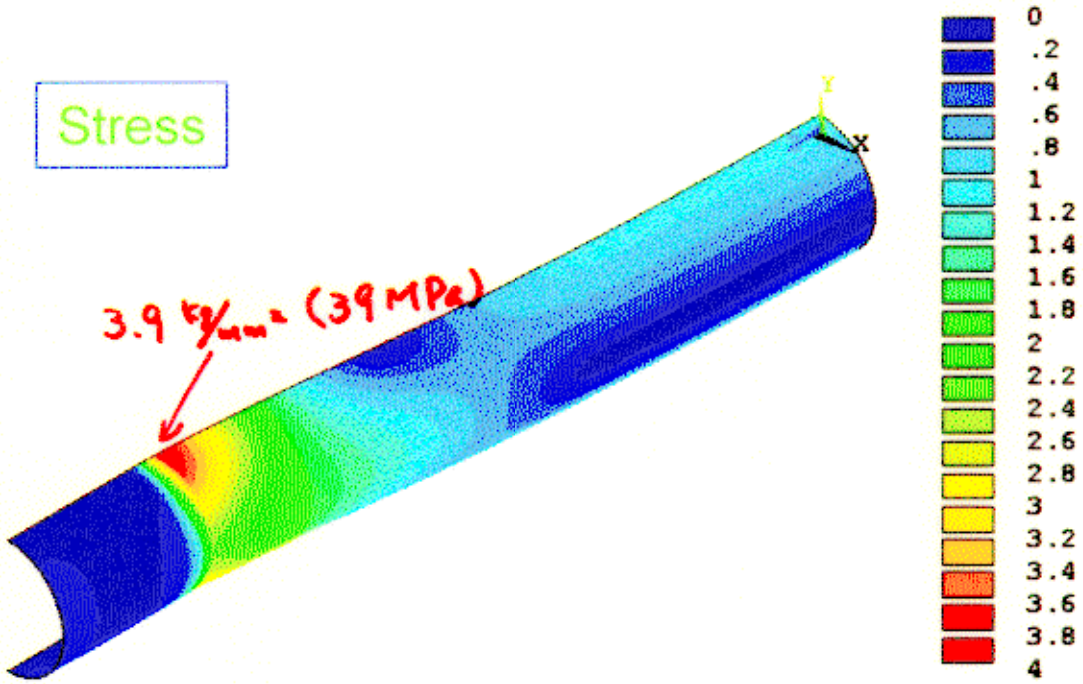



(3)-b One end fixed.

Deformation

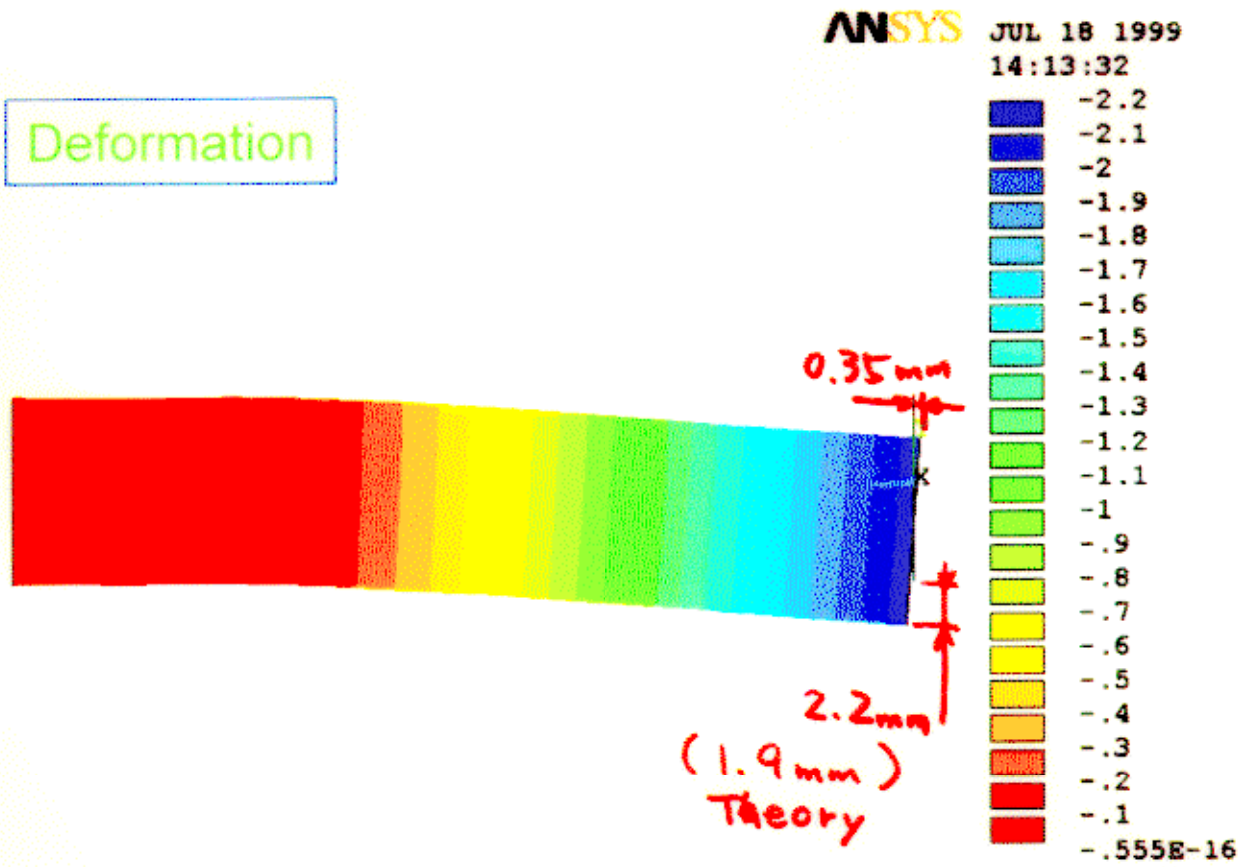

Stress

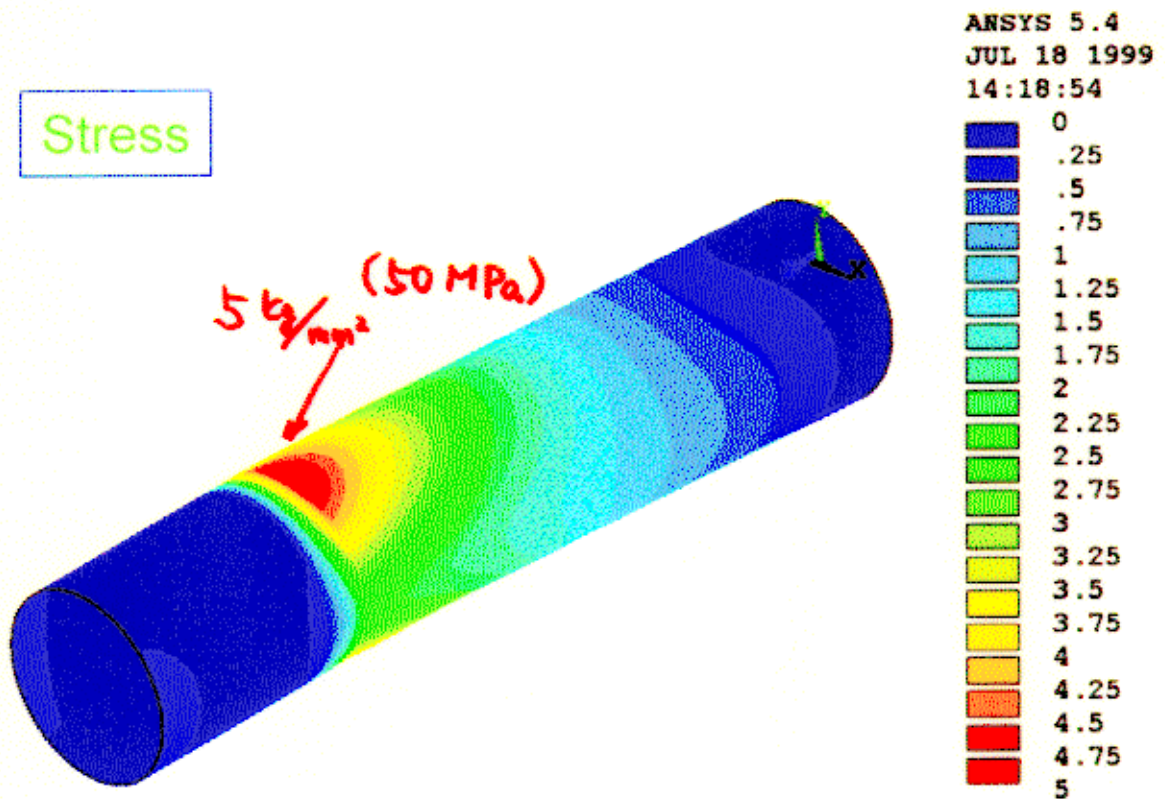

### 3. Natural Frequency

(1) In case of rigid Tungsten mask

(1)-a Simply supported at both ends

1st mode  
 $f=61.7\text{Hz}$

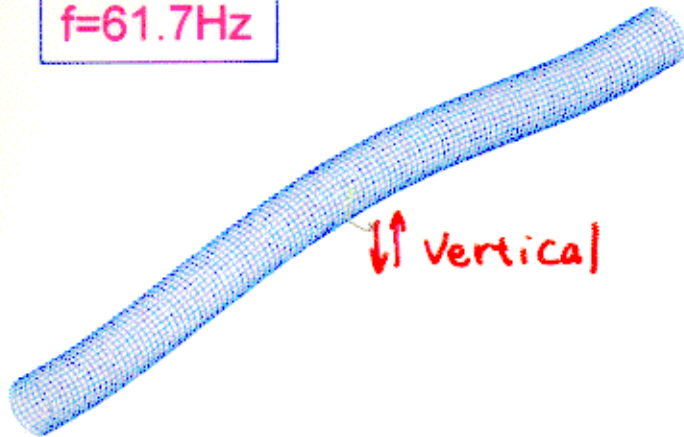

2nd mode  
 $f=61.9\text{Hz}$

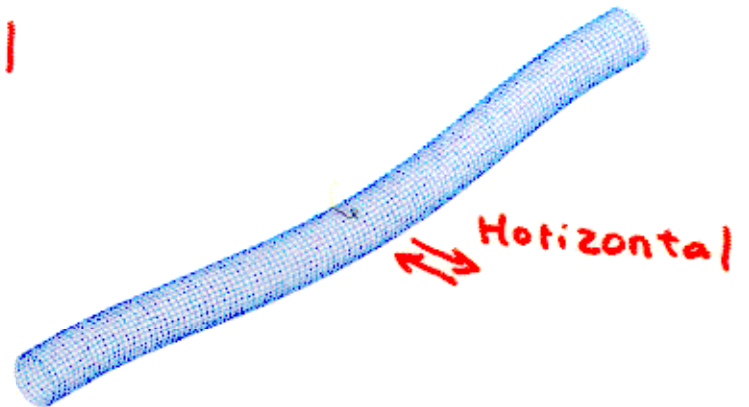

3rd mode  
 $f=70.0\text{Hz}$

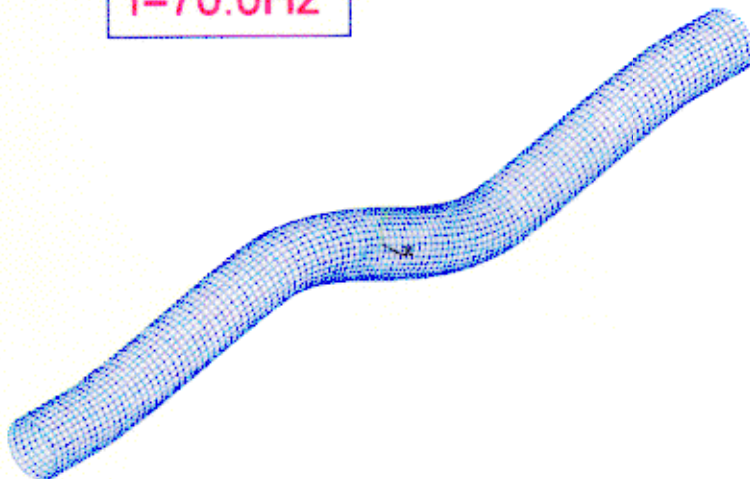

4th mode  
 $f=70.2\text{Hz}$

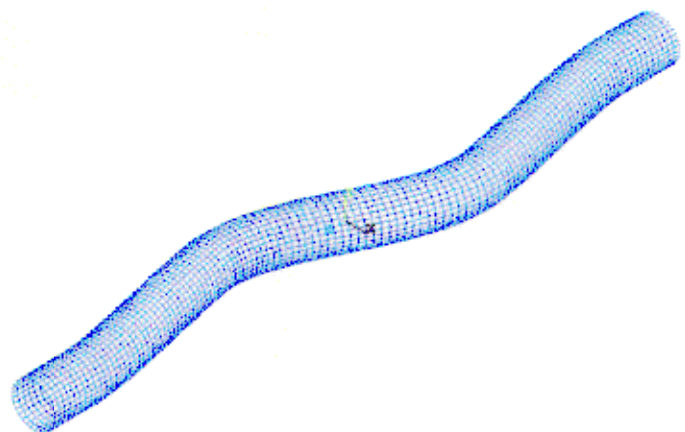

(1)-b One end fixed.

1st mode  
 $f=61.7\text{Hz}$

(Theory)  
 $60.8\text{Hz}$

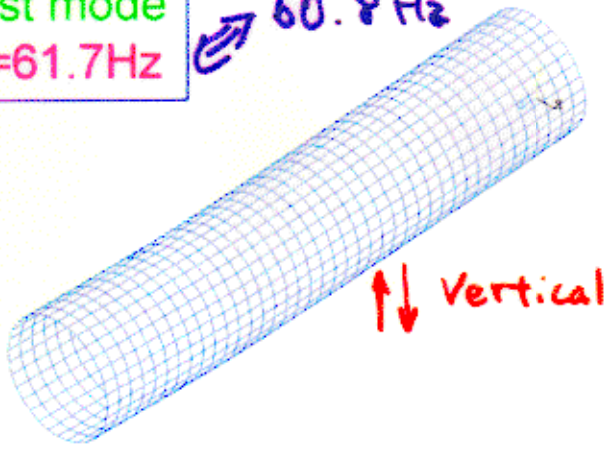

2nd mode  
 $f=61.8\text{Hz}$

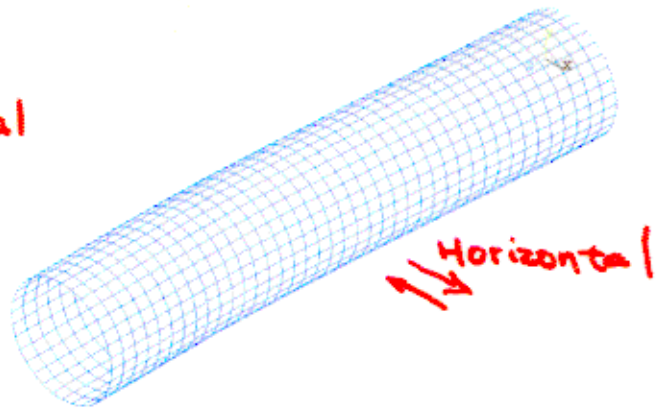

3rd mode  
 $f=152.5\text{Hz}$

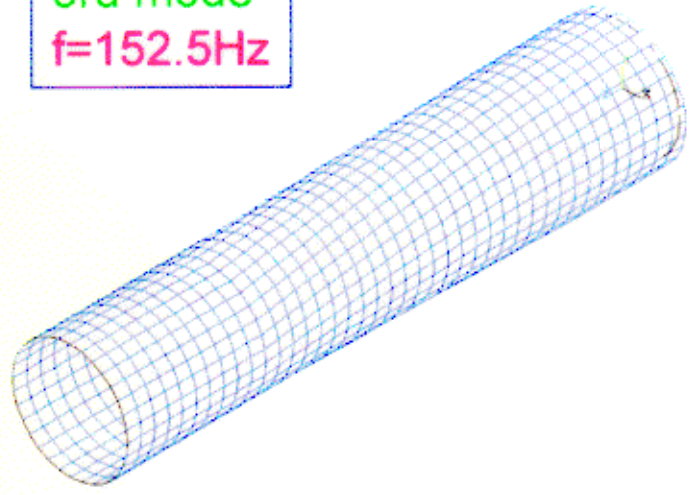

4th mode  
 $f=230.7\text{Hz}$

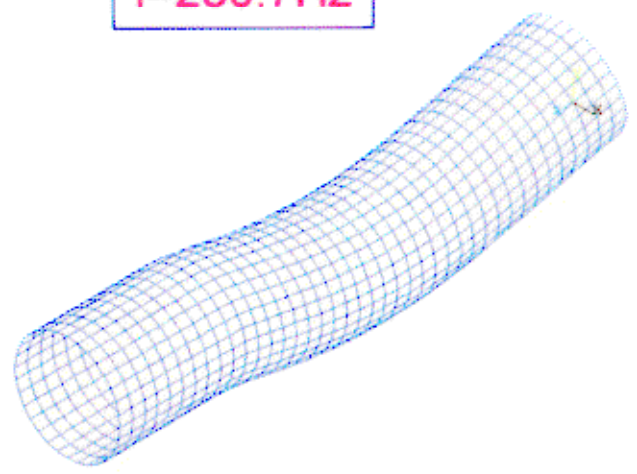

5th mode  
 $f=231.7\text{Hz}$

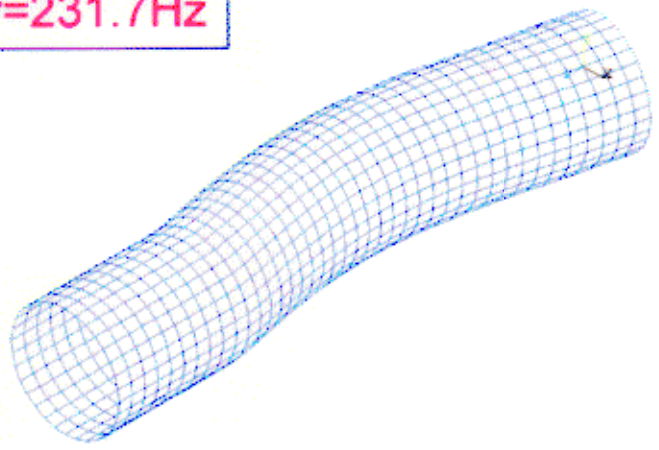



(2) In case of no rigid Tungsten mask

(1)-a Simply supported at both ends

1st mode  
 $f=11.1\text{Hz}$



2nd mode  
 $f=11.1\text{Hz}$

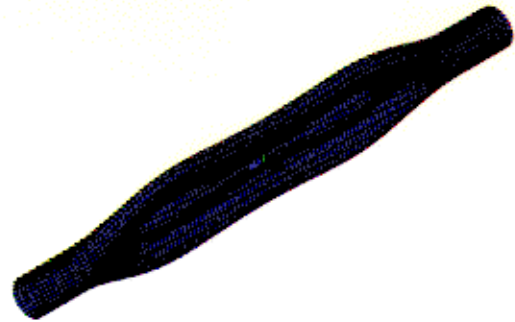

3rd mode  
 $f=11.2\text{Hz}$



4th mode  
 $f=11.2\text{Hz}$

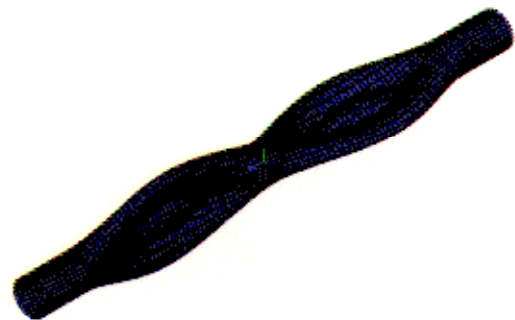

5th mode  
 $f=15.6\text{Hz}$

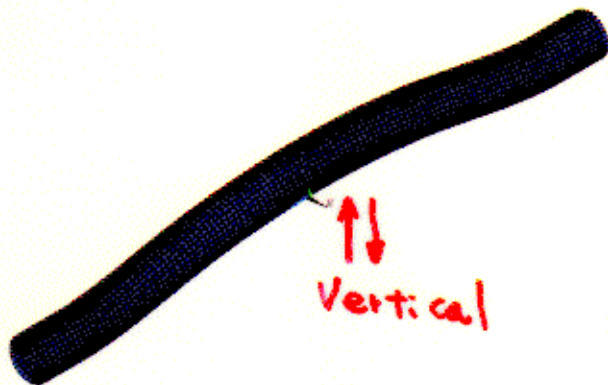

6th mode  
 $f=15.6\text{Hz}$



(2)-b One end fixed.

1st mode  
 $f=7.2\text{Hz}$

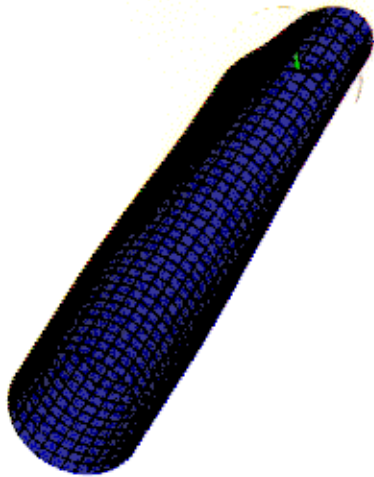

2nd mode  
 $f=7.2\text{Hz}$

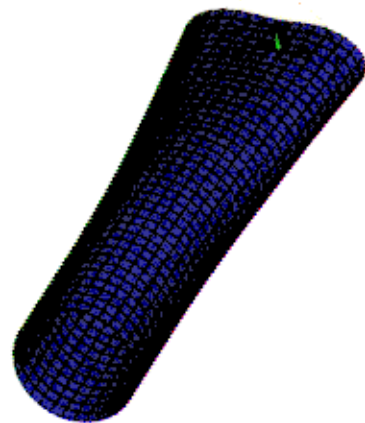

3rd mode  
 $f=12.9\text{Hz}$

$\leftrightarrow 11.5\text{ Hz (Theory)}$

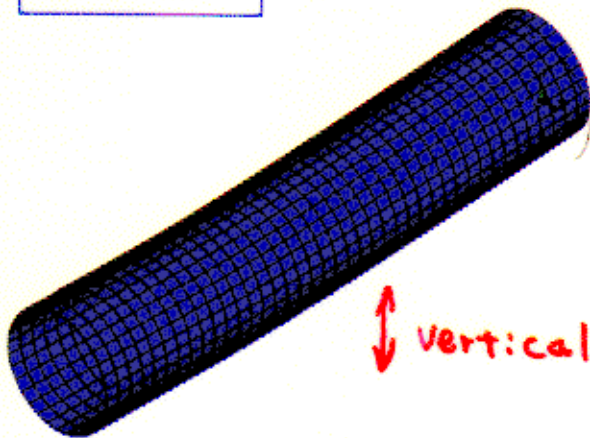

4th mode  
 $f=12.9\text{Hz}$

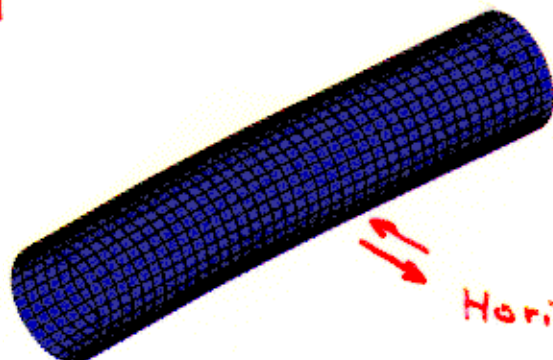

Horizontal



## 4. spectrum analysis.

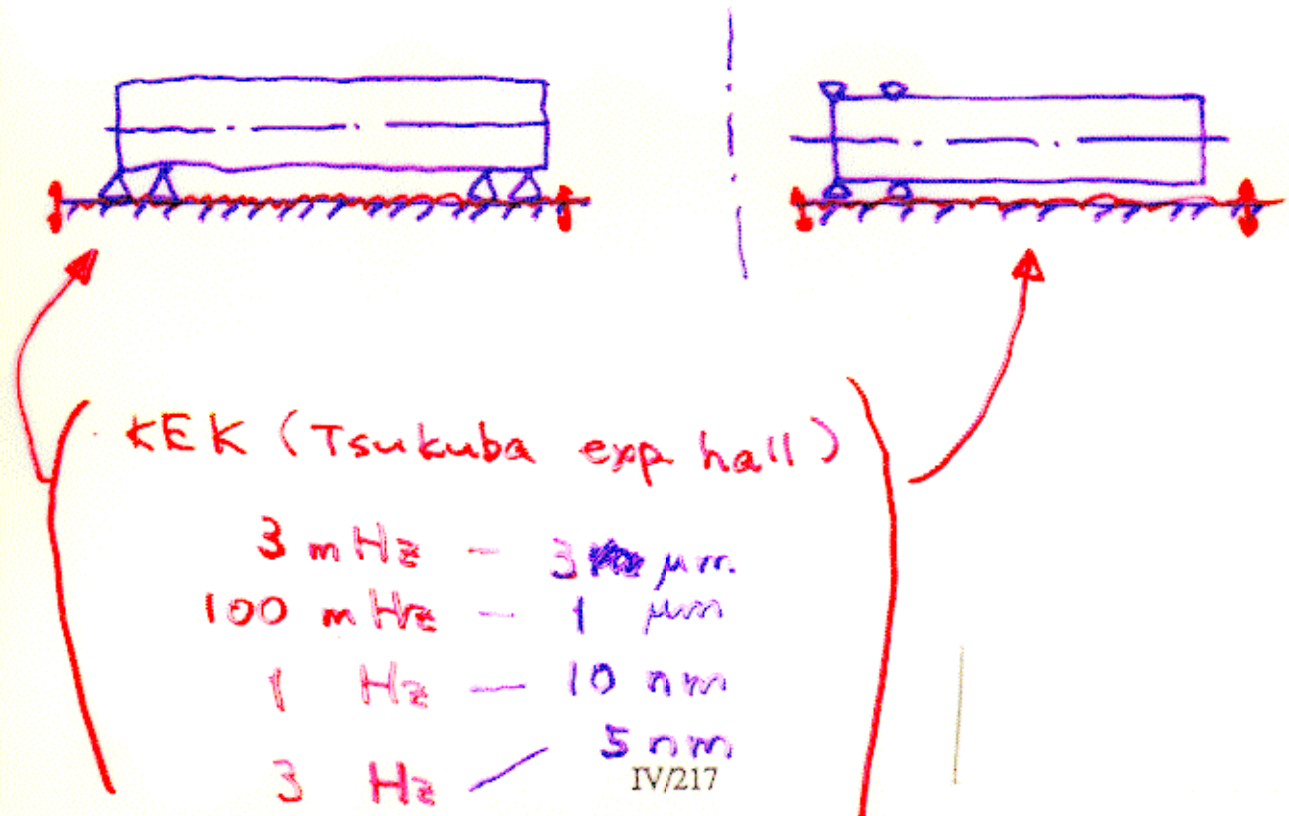

(Reference)

### MEASUREMENT OF THE SEISMIC MOTION AND THE DISPLACEMENT OF THE FLOOR IN THE TRISTAN RING

Ryuhei Sugahara, Kuninori Endo and Yasunobu Ohsawa  
National Laboratory for High Energy Physics, Tsukuba-shi, Ibaraki-ken, Japan

#### 1. INTRODUCTION

The design value for the beam size at the KEK B-factory is:

$$\sigma_x = 140 \mu\text{m} \text{ and } \sigma_y = 1.4 \mu\text{m} [1].$$

Hereafter the coordinate system is defined as: X is the horizontal axis and Y the vertical axis in the plane perpendicular to the beam axis, and Z is along the beam axis. The beam collision is sensitive to the displacement of magnets located around the interaction point. For example, if the final quadrupole magnet moves vertically by 0.1 mm or more, the luminosity will drop noticeably. TRISTAN ring, electron-positron collider with diameter of 1 km, is planned to be modified as a B-factory.

The seismic motion and the displacement of the floor at TRISTAN ring were measured. Measurement was carried out in Fuji and Tsukuba interaction regions. At TRISTAN ring are located four experimental halls; two are big halls and other two are relatively small. Fuji and Tsukuba experimental halls are big ones having almost the same structure and located diagonally each other. In the B-factory project, the collision point is to be placed in Fuji experimental hall at present. The plan view of the experimental hall is shown in Fig.1. The floor in the experimental hall is 16.5 m deep and that in the accelerator straight section is 12.1 m deep from the ground surface. In the experimental hall, magnets are fixed on the movable base whose top surface is 5.7 m high above the concrete floor.



モーダル解析

## レッスン B: 専門用語と概念

一般化運動方程式: <sup>1</sup>

M: Mass Matrix.

$$[M]\{\ddot{u}\} + [C]\{\dot{u}\} + [K]\{u\} = \{F(t)\}$$

- 自由振動状態と減衰なしを仮定:

$$\Rightarrow [M]\{\ddot{u}\} + [K]\{u\} = \{0\}$$

 $\ddot{u}$ : Acc. vector

K: Stiffness Matrix

- 周期的運動を仮定:

$$([K] - \omega^2 [M])\{u\} = \{0\}$$

↳ How much?

この方程式の根  $\omega_i^2$  は固有値を表し、ここに  $i$  の範囲は1から自由度の数までである。対応するベクトル  $\{u_i\}$  は固有ベクトルである。





## (2) Magnification

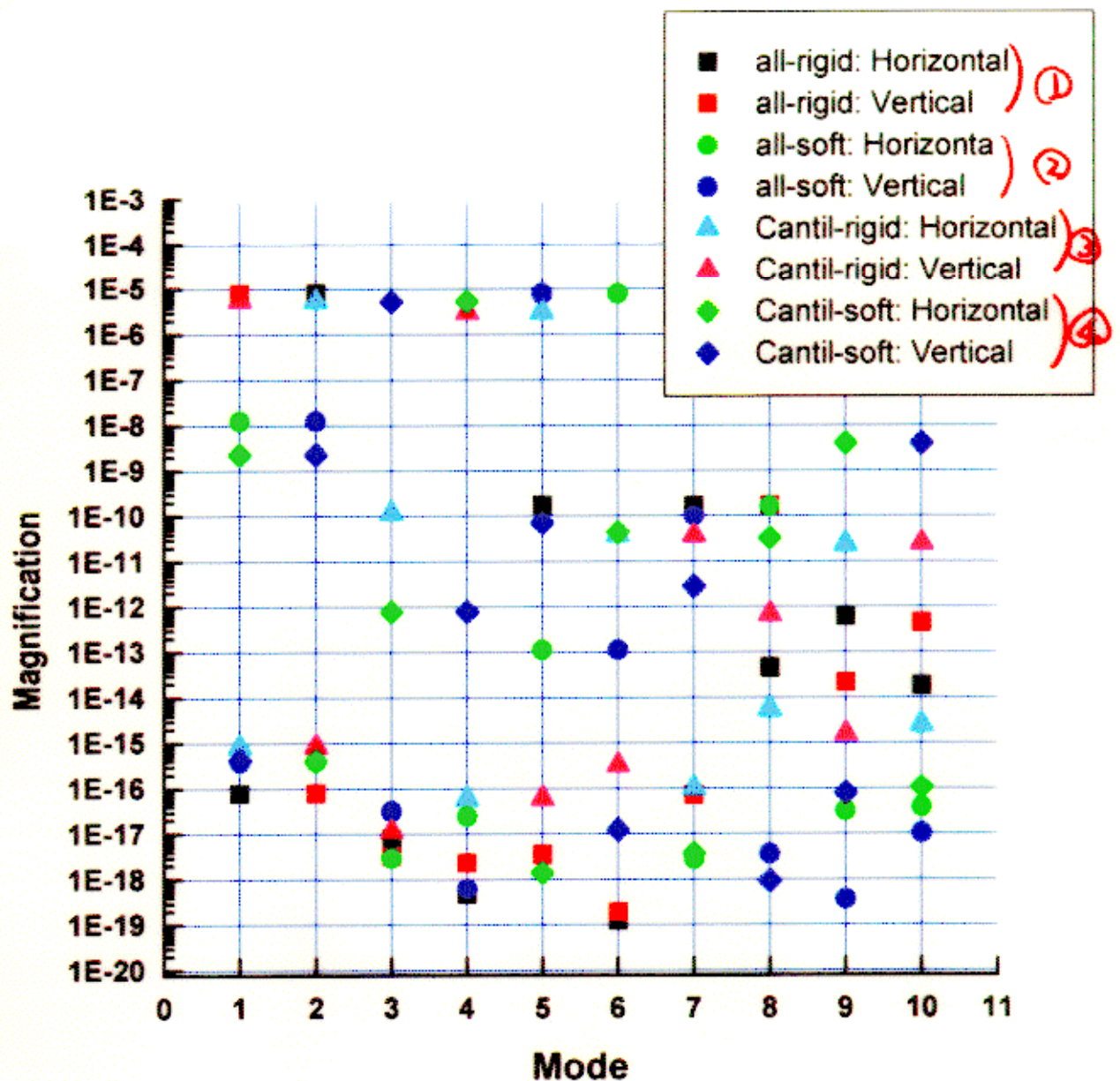
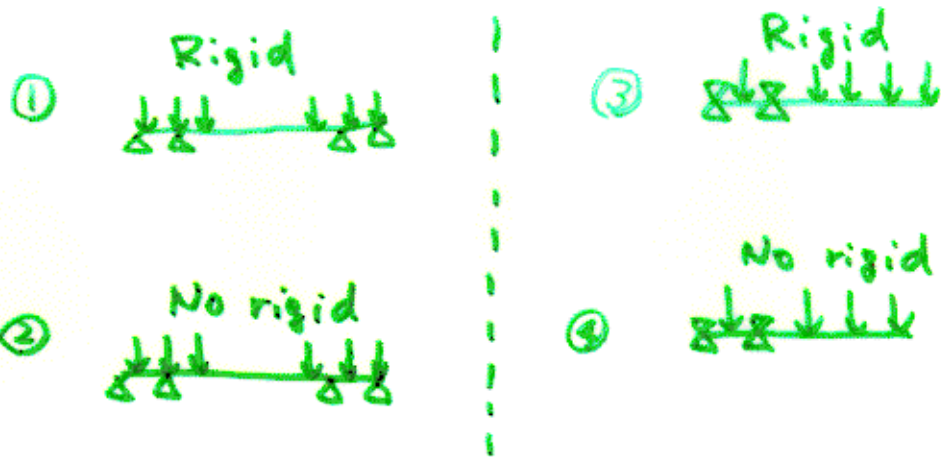



## (2) Deformation response

