

Basic Physics Behind Operation of TPC

Part 0

-- ILC Physics --

Keisuke Fujii
ILC-TPC School
Beijing: 7-11 Jan., 2008

Linear Collider Physics

A Very Quick Review

Keisuke Fujii

ILC-TPC School: Beijing, Jan., 7, 2008

Two Main Pillars of SM

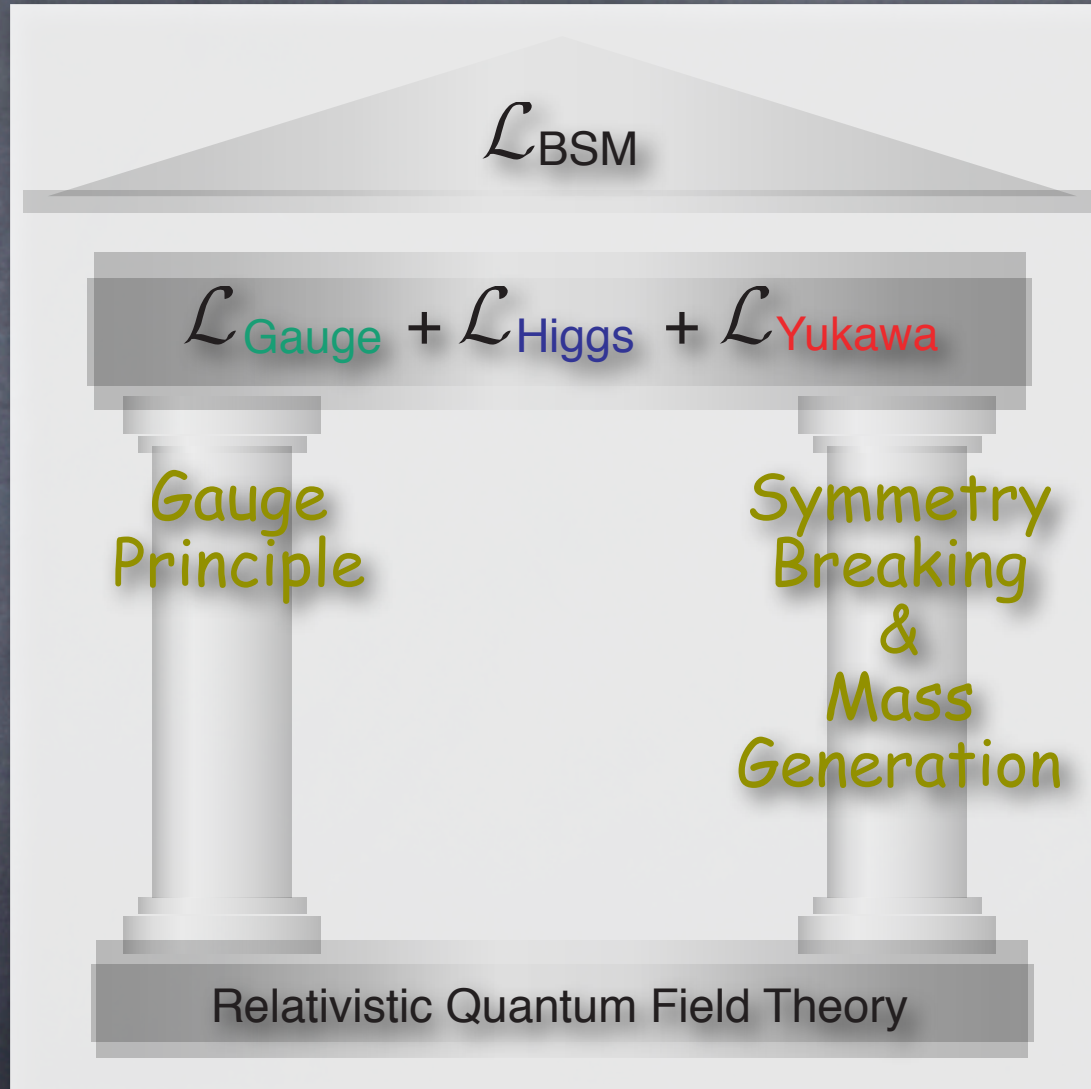

Two Main Pillars of SM

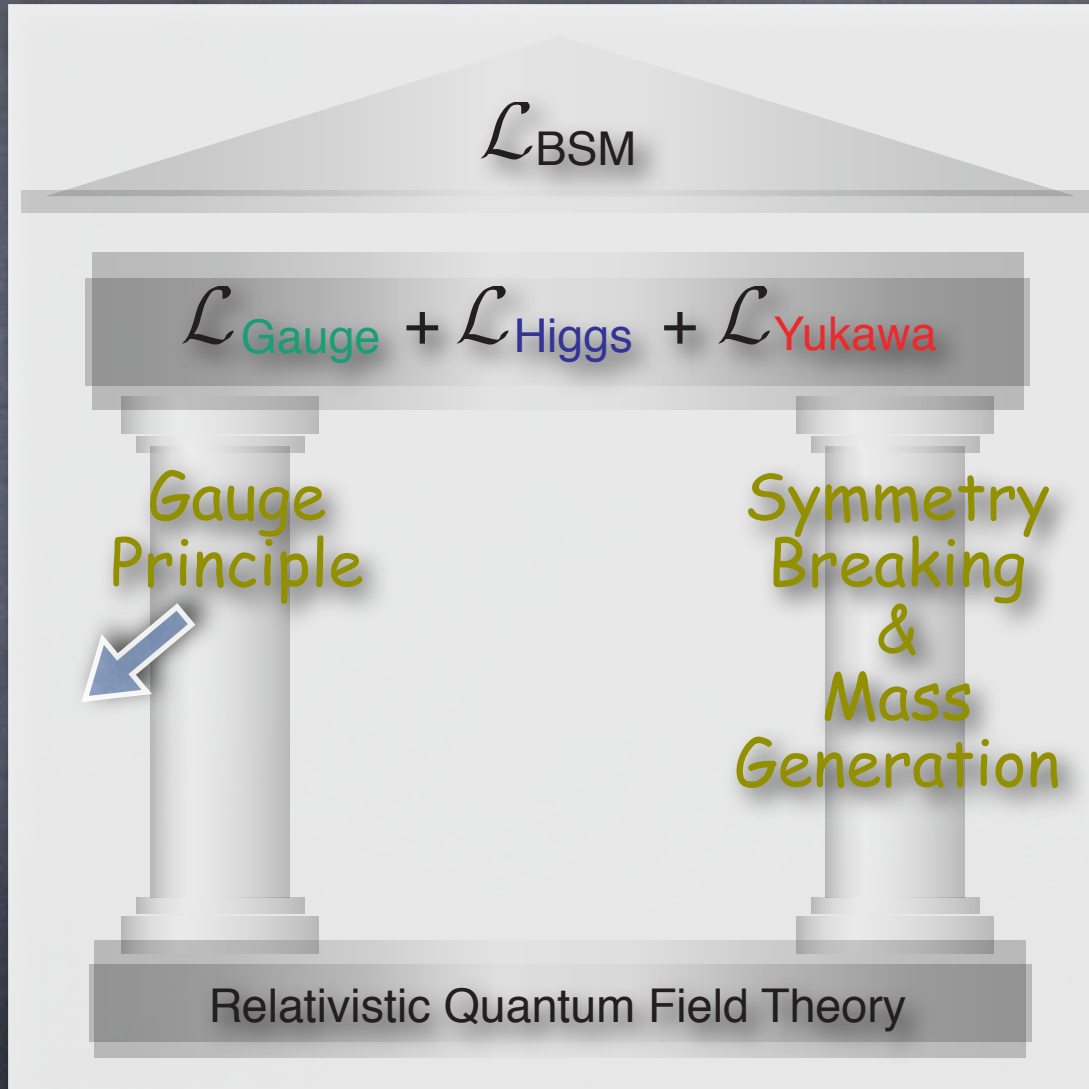

Two Main Pillars of SM

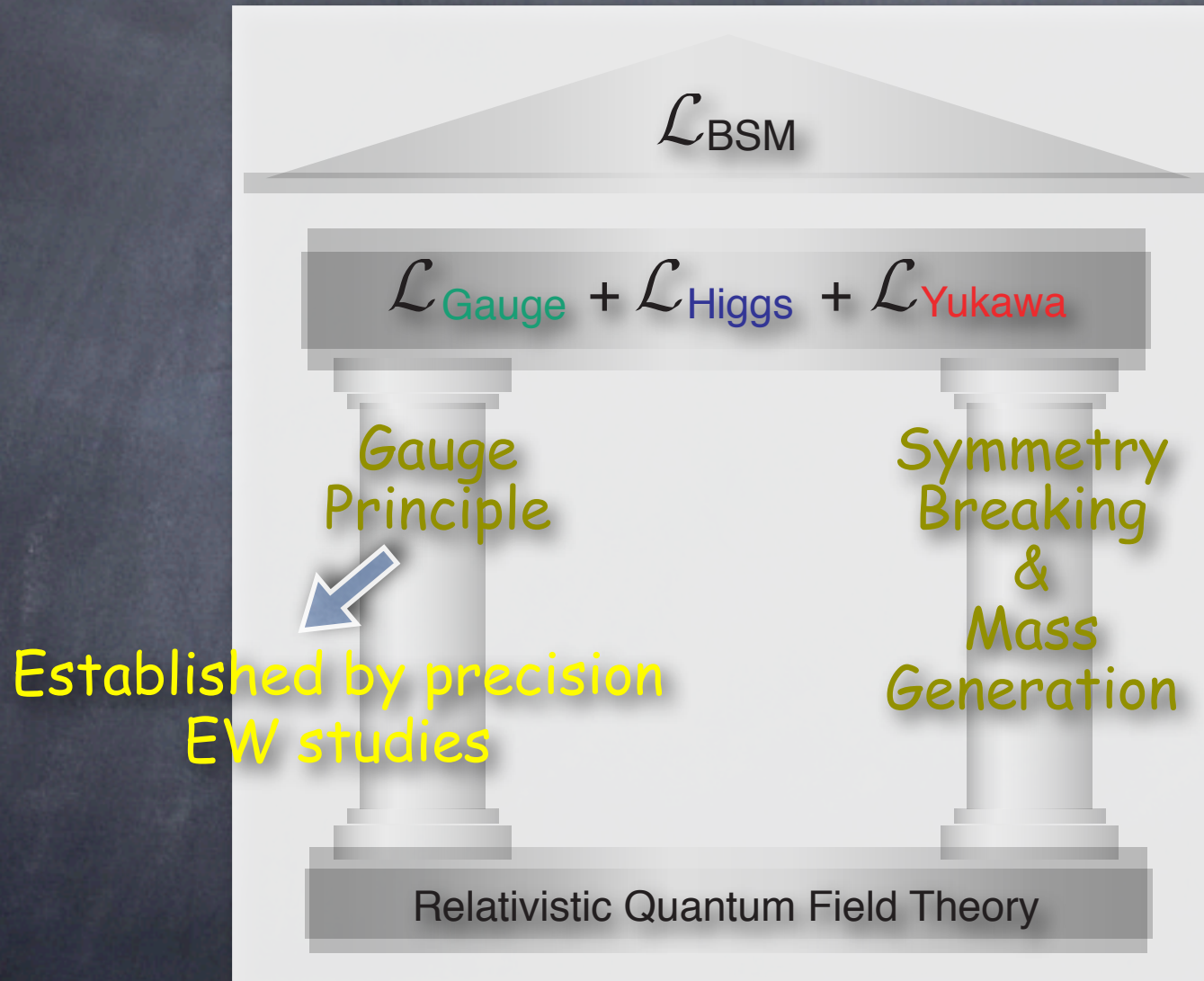

Two Main Pillars of SM

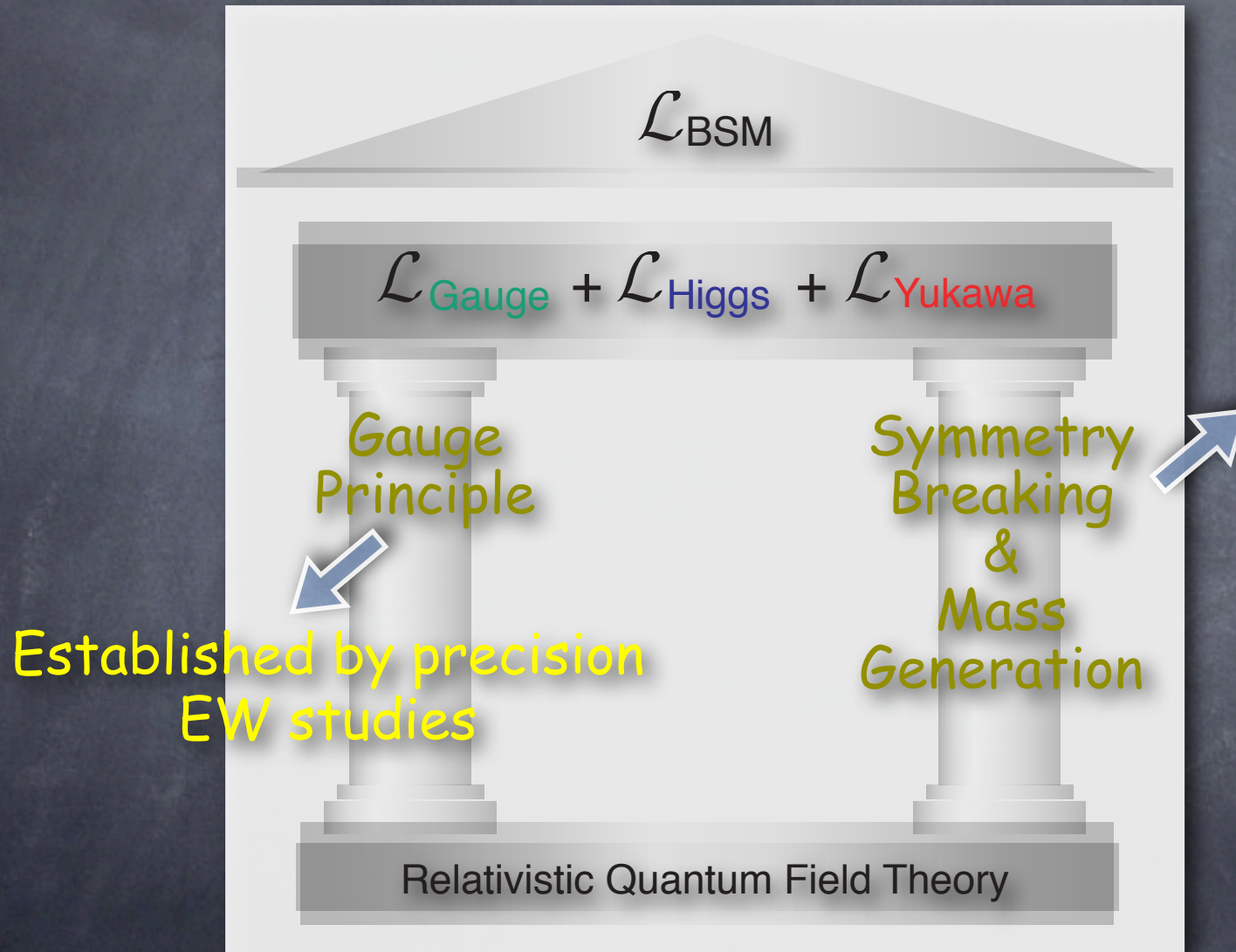

Two Main Pillars of SM

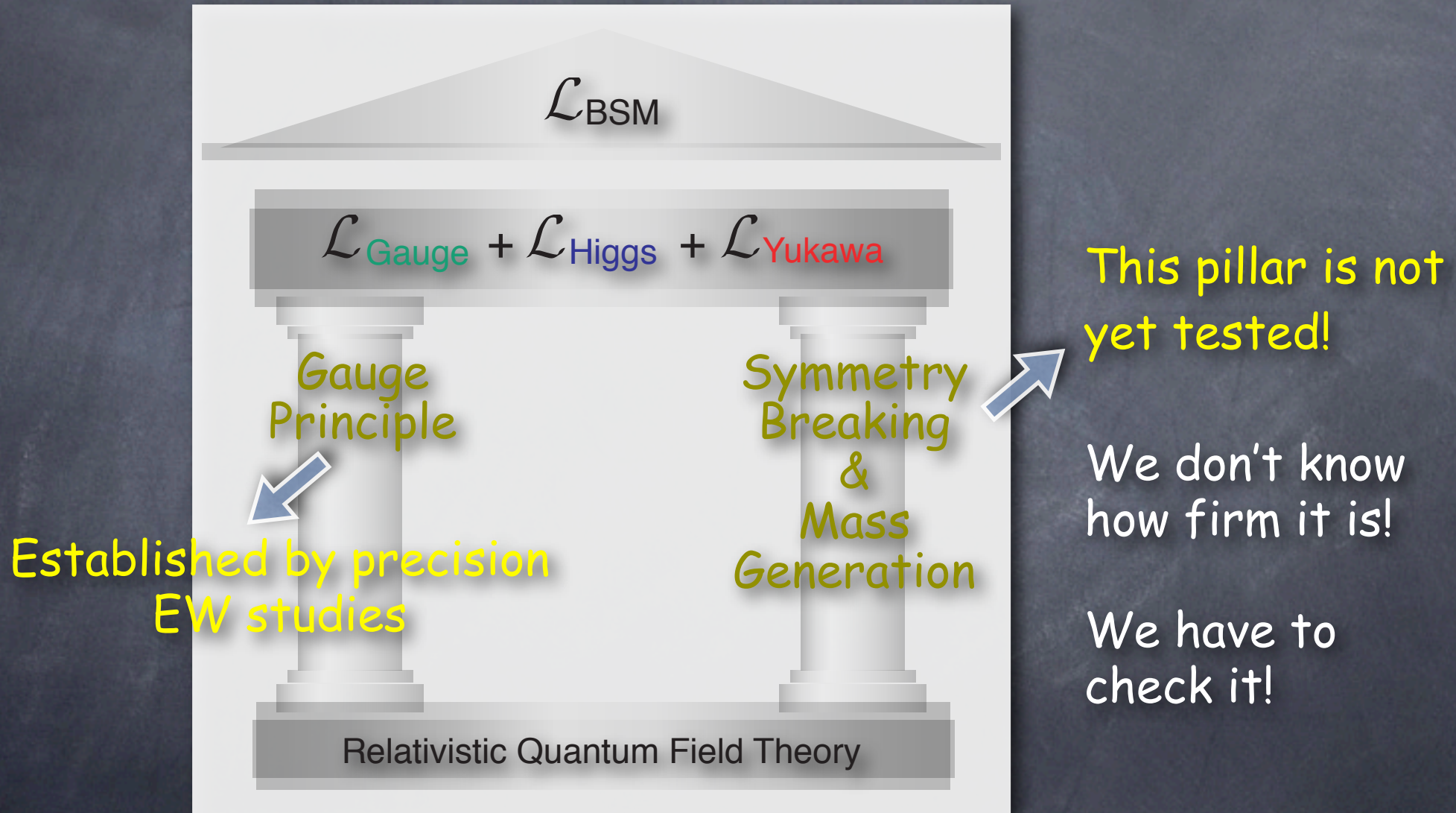

Two Main Pillars of SM

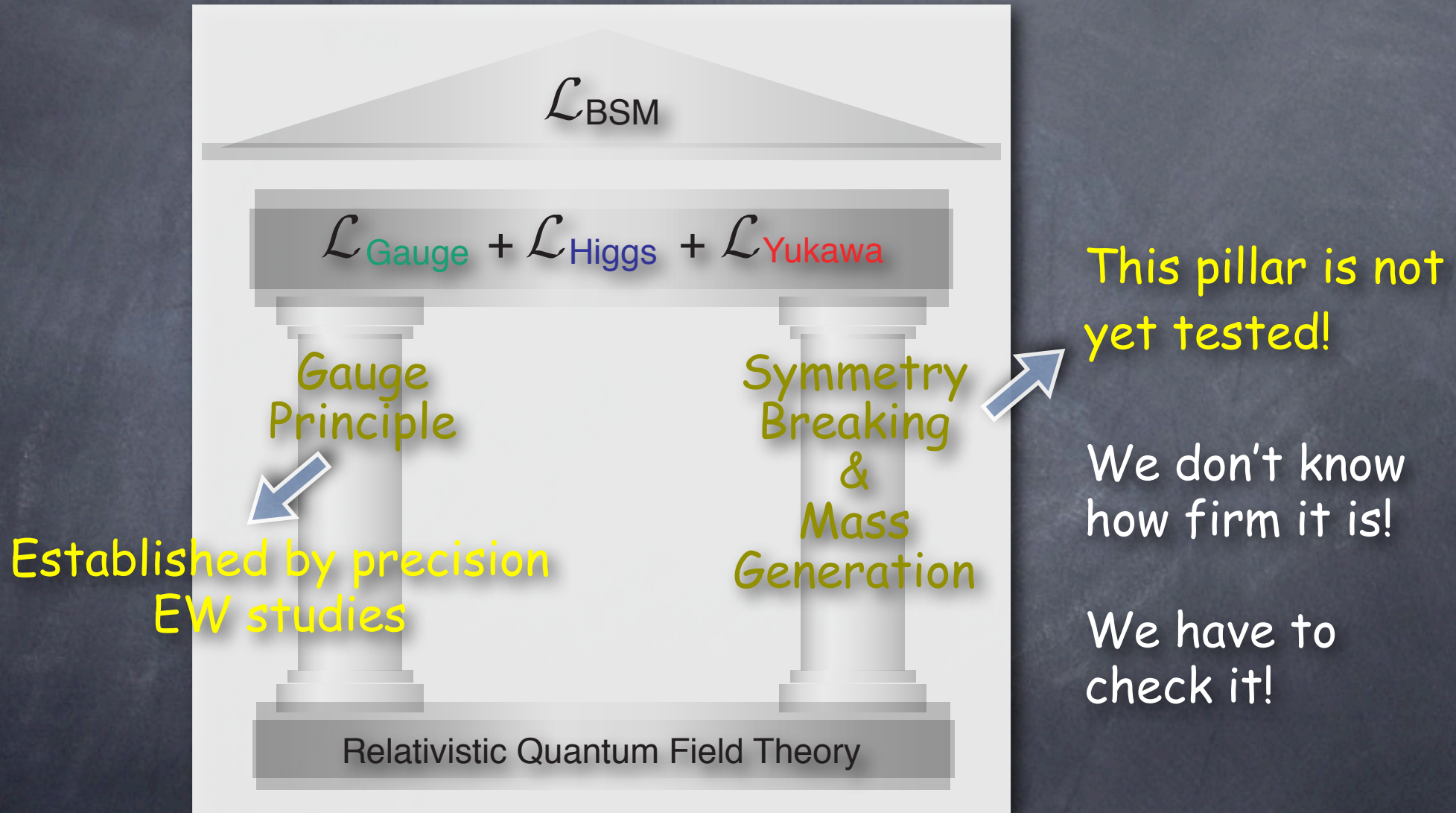

We are not yet ready to put the BSM roof!

We have LHC to test the
2nd pillar.

Then why do we need LC?

What is special about it?

Concept of LC Experiment

- Reconstruct final states in terms of partons (q,l,gb)

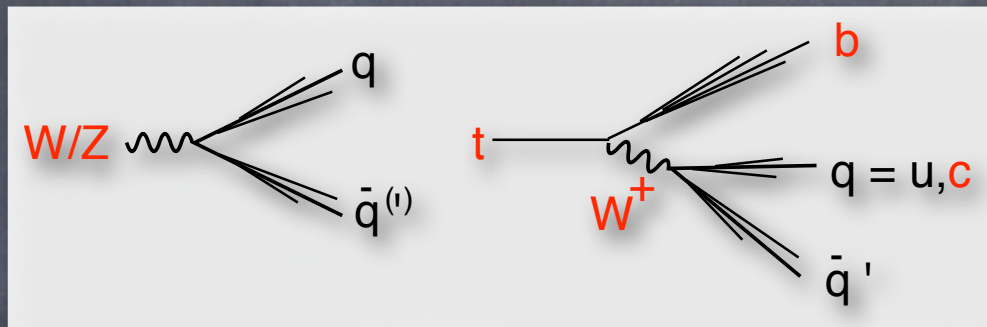

2ndary & 3tiary
vertex ID

Jet invariant mass --> W/Z/t ID --> p^μ
--> angular analysis --> S^μ

Energy Flow

Missing momentum --> neutrinos

Hermeticity



Visualize events as viewing Feynman diagrams!

Select Feynman diagrams with beam polarization

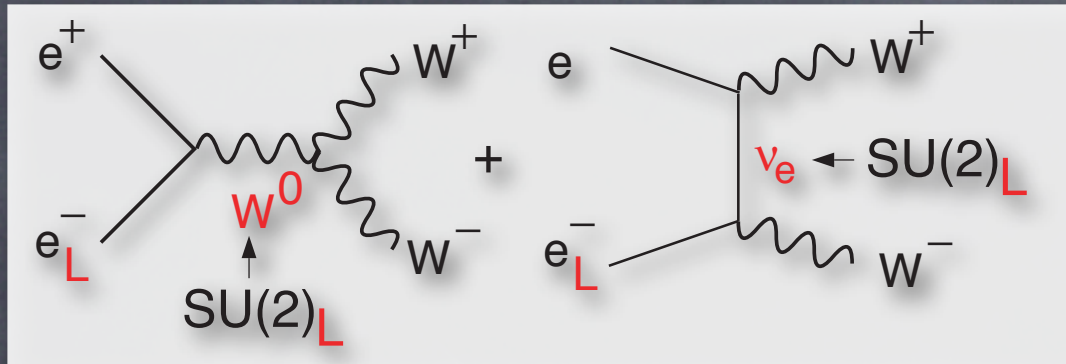

In the symmetry limit
 $\sigma_{WW} \rightarrow 0$
for R-handed e- beam



Study events as looking at S-matrix elements!

This requires a state-of-the-art detector!

2ndary & 3tiary vertex ID

Thin and high resolution vertexing

Energy Flow (PFA)

High resolution tracking

High granularity calorimetry

Hermeticity

down to $O(10\text{mrad})$ or better

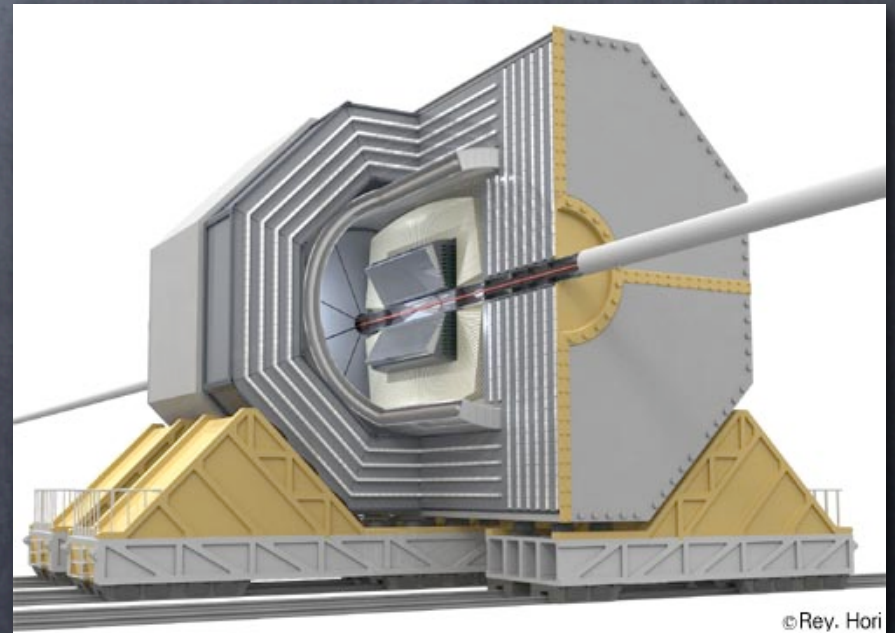

©Rev. Hori

Particle Flow Analysis

- How can we determine Ejet precisely?

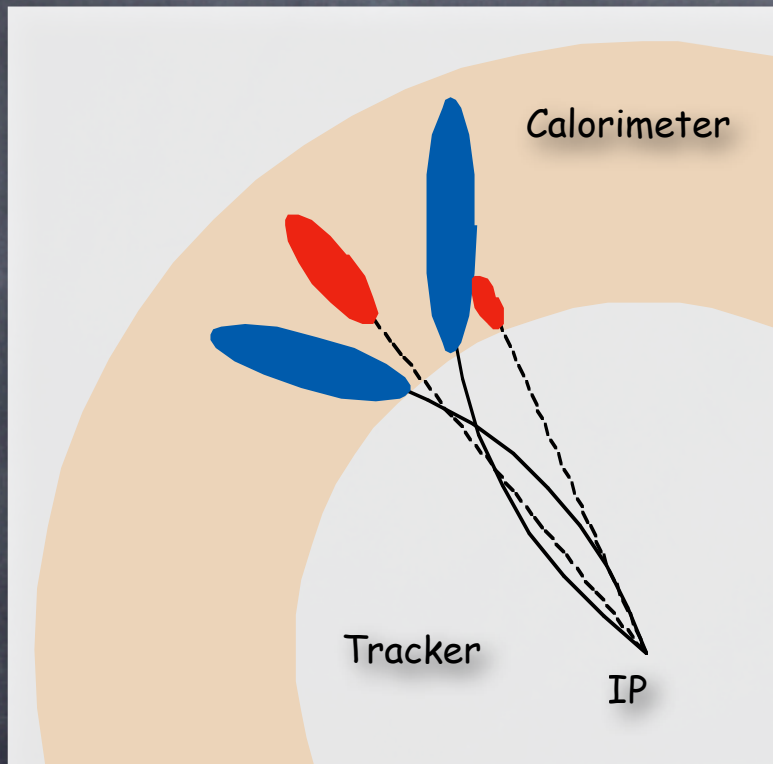

For charged particles

Use Tracker info. since it's much better than that from CAL

For neutral particles

Use CAL since no other choice



CAL information only for neutral particles

Need to remove CAL hits by charged particles : PFA

What kind of test of the
2nd pillar can LC make?

What Breaks EWS?

Once a Higgs-like particle is found,
LC can make precision measurements of its basic properties

- For a 120 GeV Higgs boson, LC can measure, with 500 fb⁻¹,
 - the Higgs mass to 40 MeV
 - the Higgs width to 6%
- and confirm that it is indeed spinless

Then we can say we find a Higgs-like spinless boson

Recoil Mass Measurement

We can measure H even if it decays totally invisibly

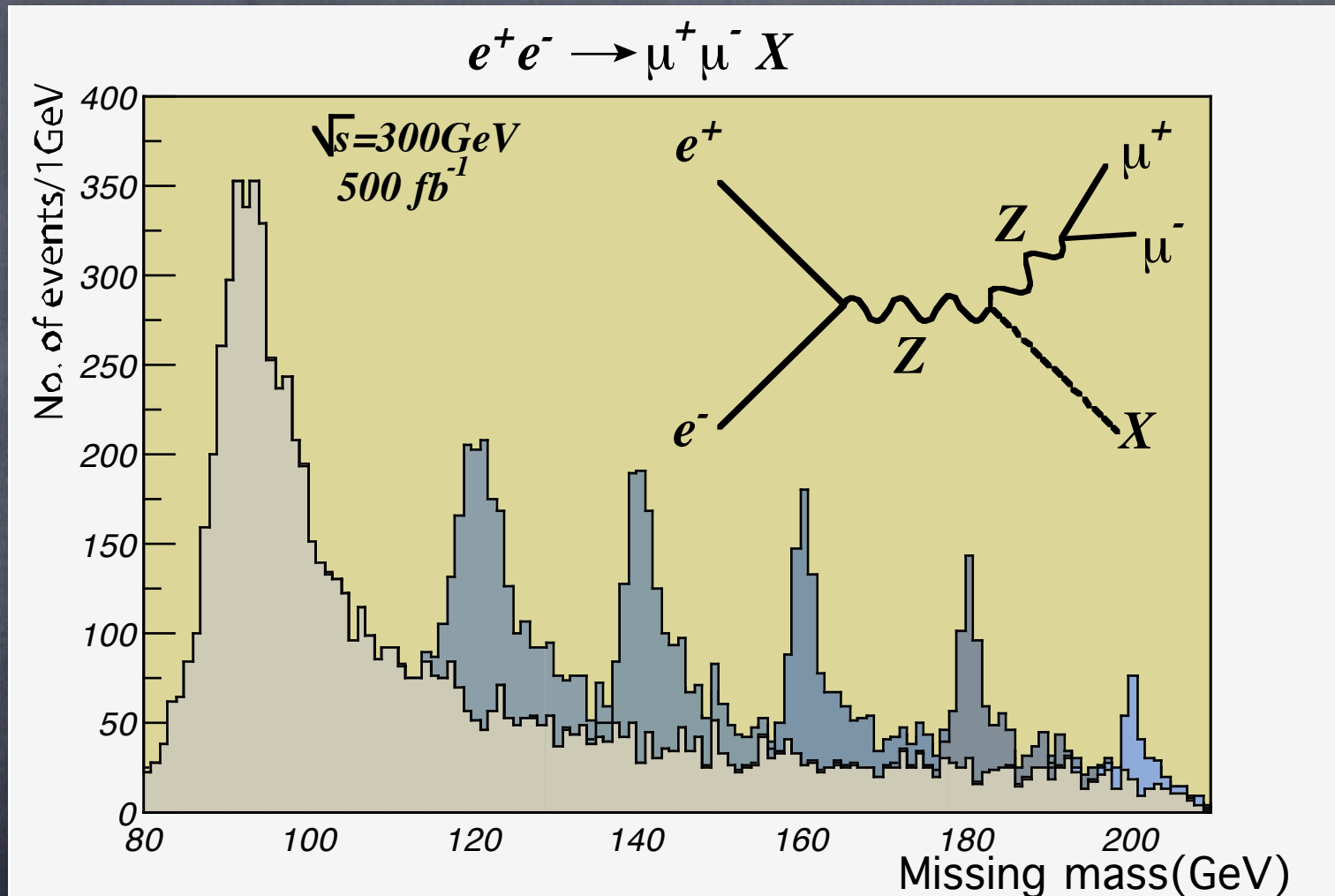

$$M_X^2 = \left(p_{CM} - (p_{\mu^+} + p_{\mu^-}) \right)^2$$

What is the dynamics behind it?

- The Discovery of a Higgs-like boson is not enough! We need to observe the force that makes the Higgs boson condense in the vacuum

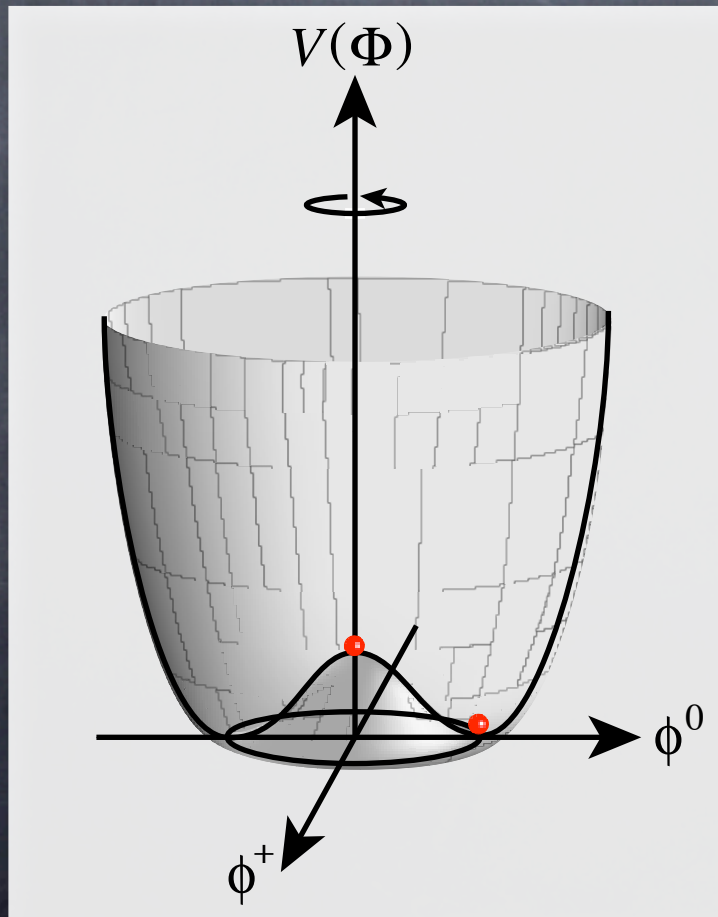

We need to measure the shape of the Higgs pot.

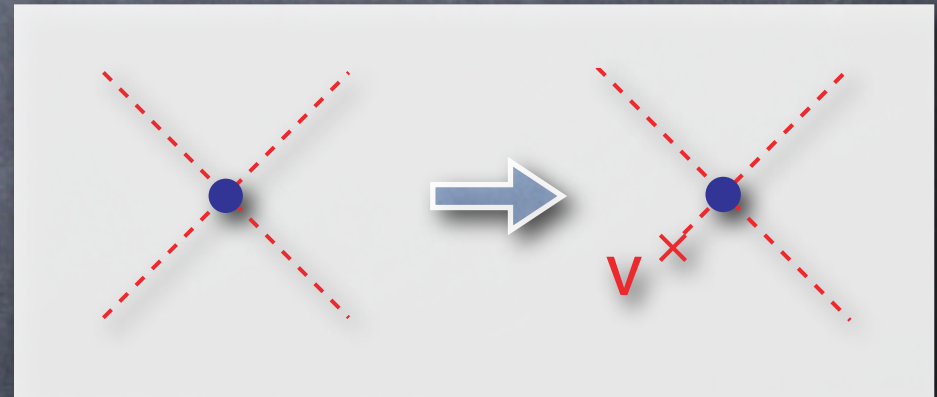

We need to measure the Higgs self coupling!

Then How?

Standard Ways

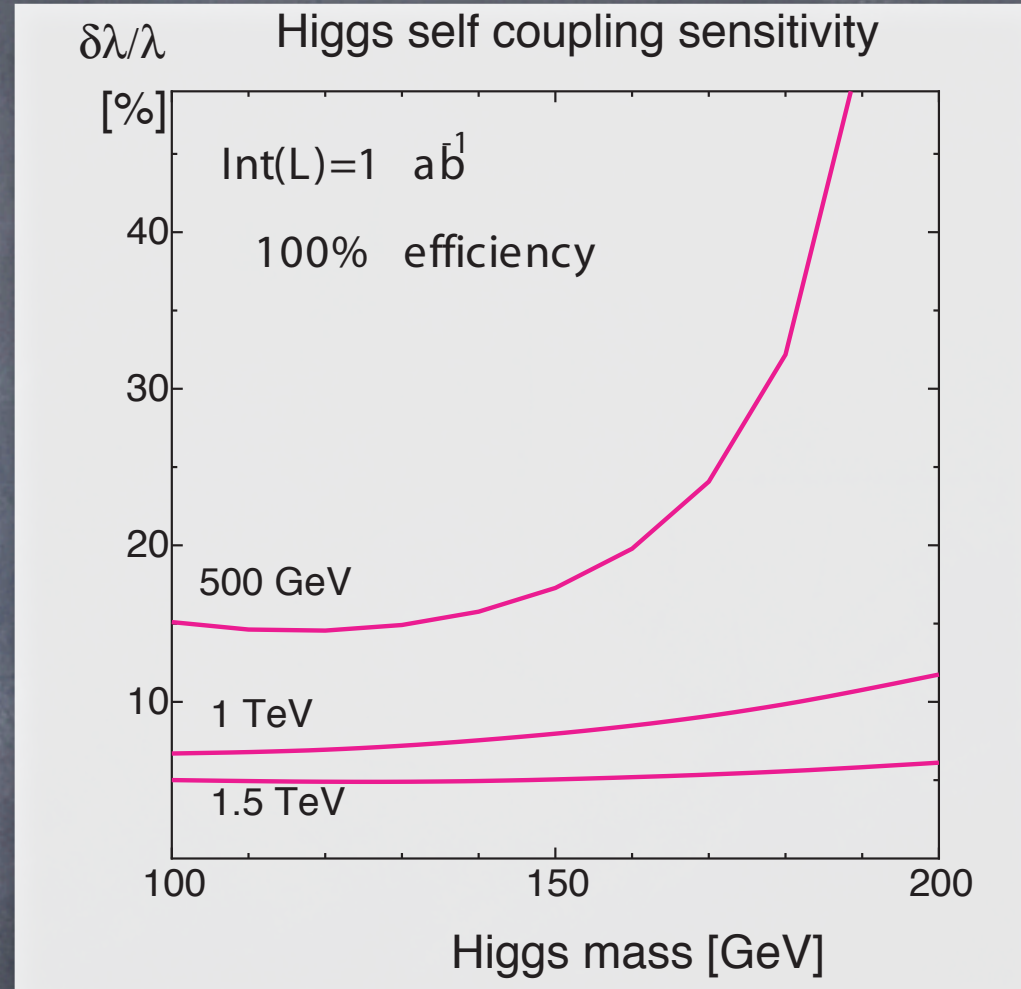
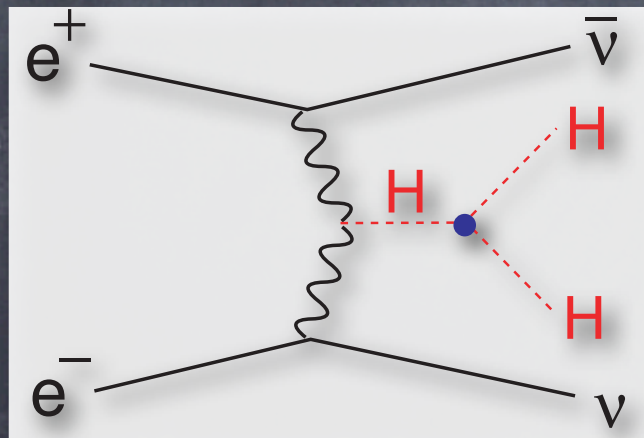
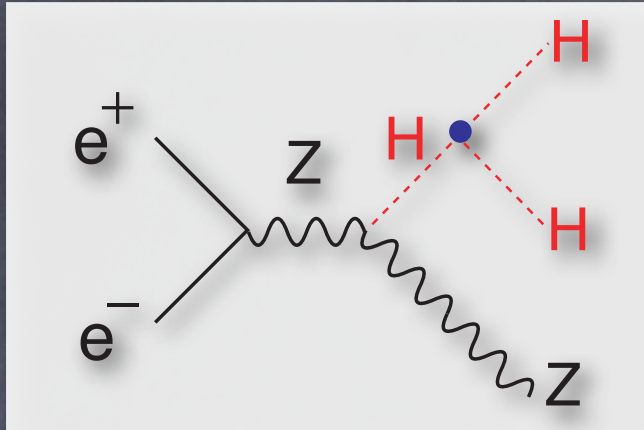

The self coupling can be measured to $O(10\%)$

Another Way

We might be able to do better with a photon collider at the HH threshold (Belusevic & Jikia)

Origin of Mass

- If the Higgs boson is the one to give masses to all the SM particles, we need to observe proportionality between mass and coupling

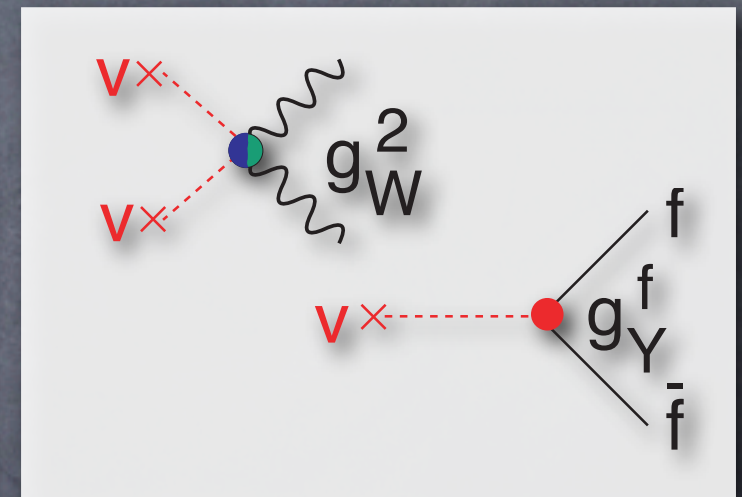
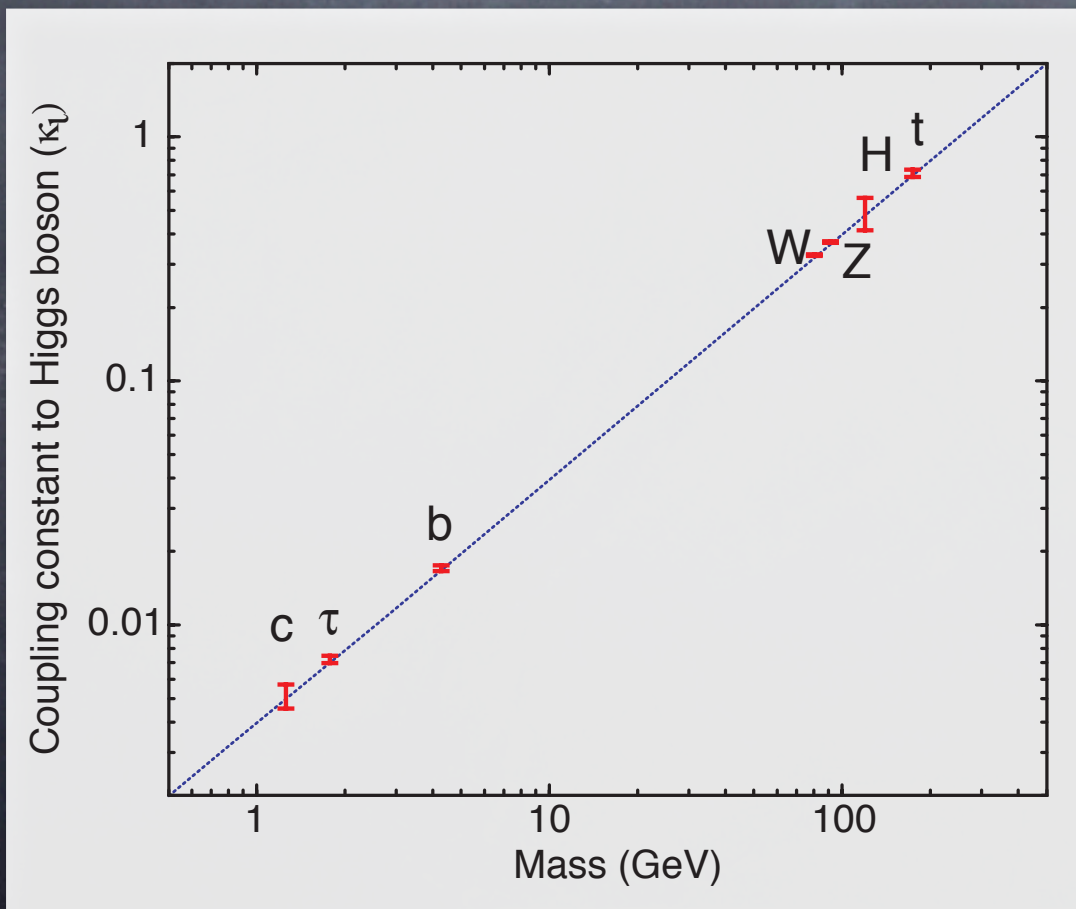

Might see two or more lines if the Higgs sector is non-minimal!

Then We will be Able to
Go Beyond the SM

Popular BSM Scenarios

BSM = Extra Dims./Symms.

- In the Case of High Cut-off Scale
 - Supersymmetry (Fermionic Dimensions)
The most well motivated and studied
 - ???
- In the Case of Low Cut-off Scale
 - Large Extra Dimension (Bosonic Dims.)
 - Extra Symmetries (New Strong Int.?)
 - Little Higgs
 - Techni-Color
 - ???

Popular BSM Scenarios

BSM = Extra Dims./Symms.

- In the Case of High Cut-off Scale
 - Supersymmetry (Fermionic Dimensions)
The most well motivated and studied
 - ???
- In the Case of Low Cut-off Scale
 - Large Extra Dimension (Bosonic Dims.)
 - Extra Symmetries (New Strong Int.?)
 - Little Higgs
 - Techni-Color
 - ???

Supersymmetry

Standard BSM

SUSY Studies at LC

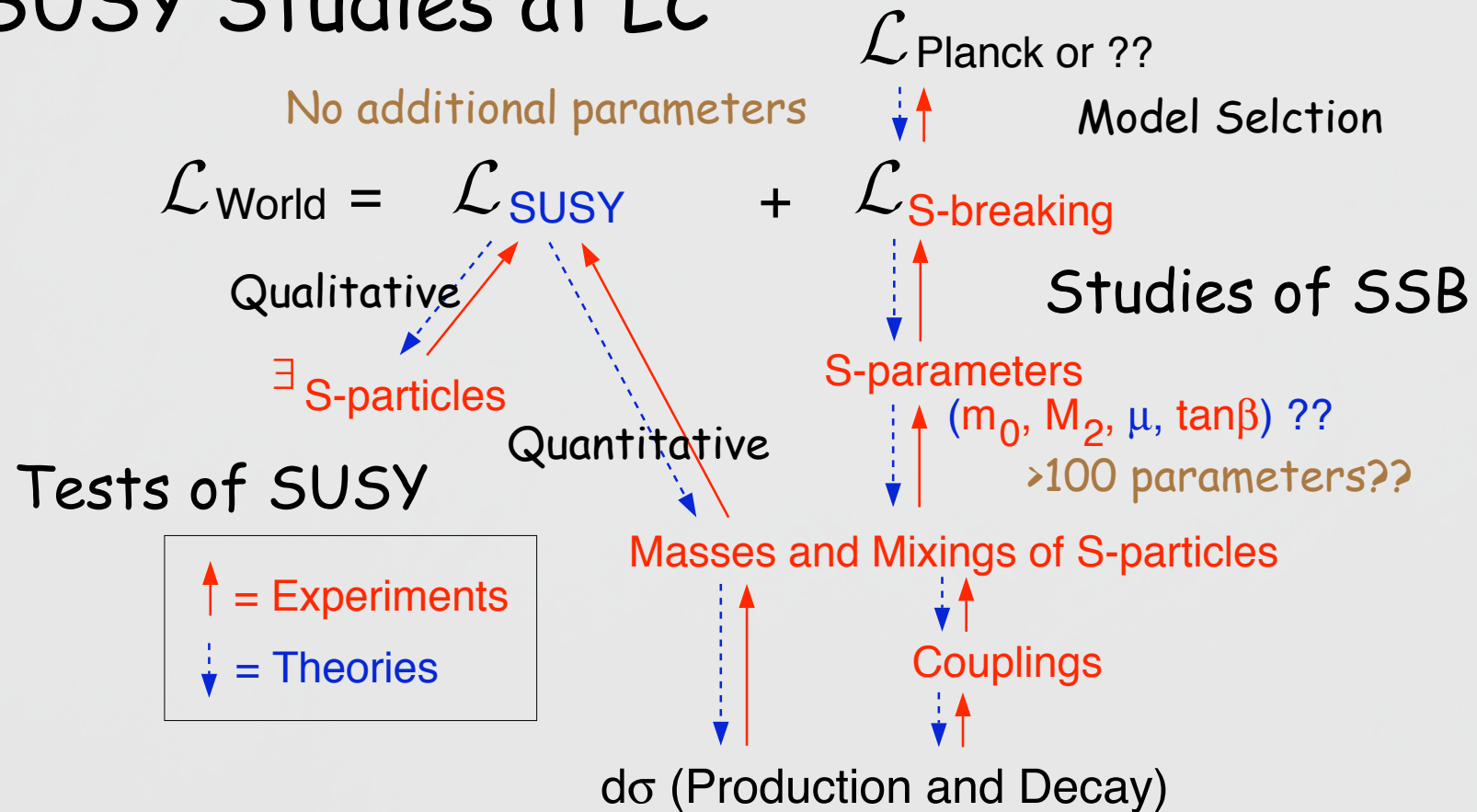

How well can we measure them model-independently?

Sample SSB Scenarios

Need for Super Spectroscopy

	Gravity Mediated	Gauge Mediated	Anomaly Mediated
Gravitino Mass	$M_{SSB}^2 / \sqrt{3} M_{pl} \sim TeV$ ($M_{SSB} \sim 10^{10} - 10^{11} GeV$)	$(\sqrt{F} / 100 TeV)^2 eV$ $10 < \sqrt{F} < 10^4 TeV$	$\sim 100 TeV$
Gaugino Mass	$M_i = \left(\frac{\alpha_i}{\alpha_2} \right) M_2$ $M_1 : M_2 : M_3 = 1 : 2 : 7$		$M_i = \left(\frac{b_i}{b_2} \right) \left(\frac{\alpha_i}{\alpha_2} \right) M_2$ $M_1 : M_2 : M_3 = 2.8 : 1 : 8.3$
Sfermion Mass	$m_{\tilde{f}}^2 = m_0^2 + \sum_i G_{\tilde{f},i} M_i^2$ $m_{\tilde{l}} < m_{\tilde{q}} \quad m_{\tilde{f}_R} < m_{\tilde{f}_L}$	$m_{\tilde{f}}^2 = \sum_i G'_{\tilde{f},i} M_i^2$ $m_{\tilde{l}} \ll m_{\tilde{q}}$	$m_{\tilde{f}}^2 = m_0^2 + \sum_i 2a_{\tilde{f},i} b_i \left(\frac{\alpha_i}{\alpha_2} \right)^2 M_2^2$ $m_{\tilde{l}_R} \approx m_{\tilde{l}_L}$
LSP	$\tilde{\chi}_1^0 \approx \tilde{B}$	\tilde{G}	$\tilde{\chi}_1^0 \approx \tilde{W}$

$$\beta_i = -b_i g_i^3 / (4\pi)^2$$

$$b_1 = 33/5 \quad b_2 = 1 \quad b_3 = -3$$

More? -> Theorists

Power of Beam Polarization

W^+W^- (Largest SM BG)

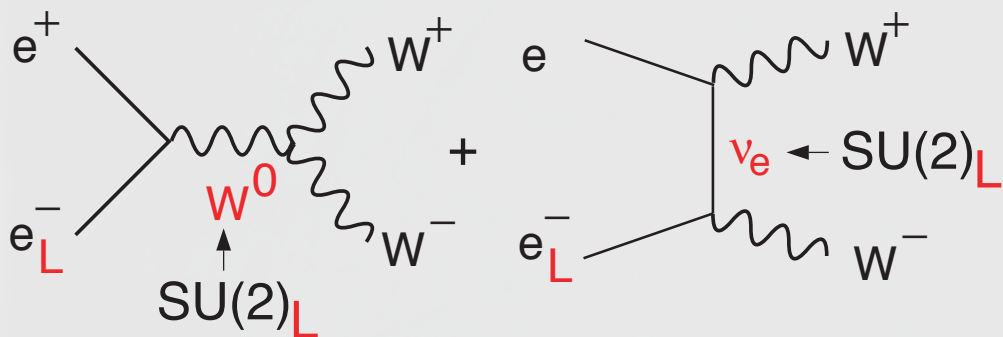

In the symmetry limit, $\sigma_{WW} \rightarrow 0$ for e^-_R !

Slepton Pair

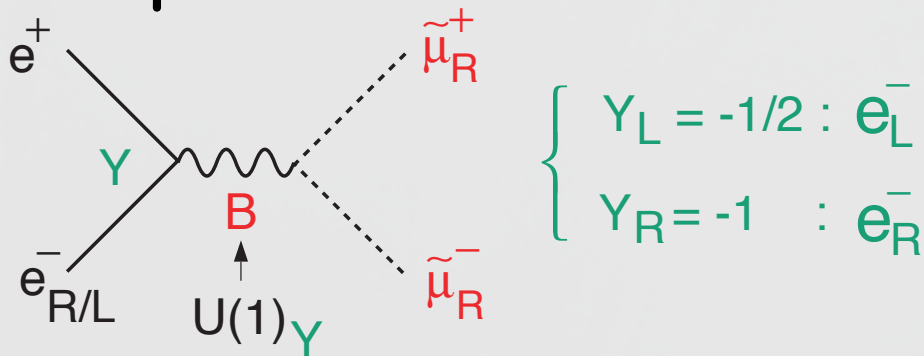

In the symmetry limit, $\sigma_R = 4 \sigma_L$!

BG Suppression

Chargino Pair

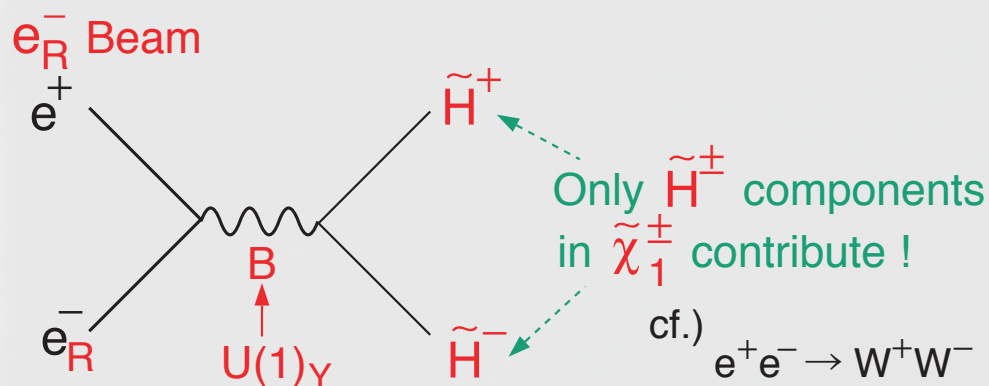

$$\tilde{\chi}_1^\pm = \text{white circle} \cdot \tilde{W}^\pm + \text{red circle} \cdot \tilde{H}^\pm$$

\parallel
 $\langle \tilde{H}^\pm | \tilde{\chi}_1^\pm \rangle$

Decomposition

Signal Enhancement

Slepton Studies

Signature = acoplanar Lepton Pair

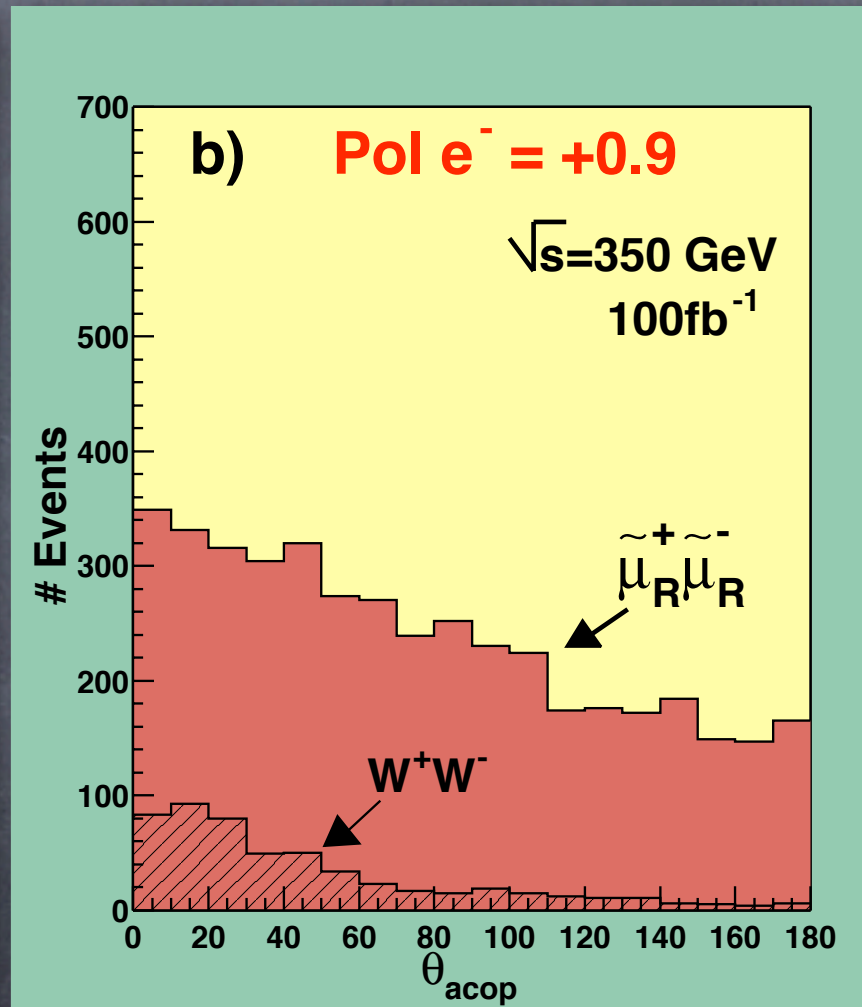
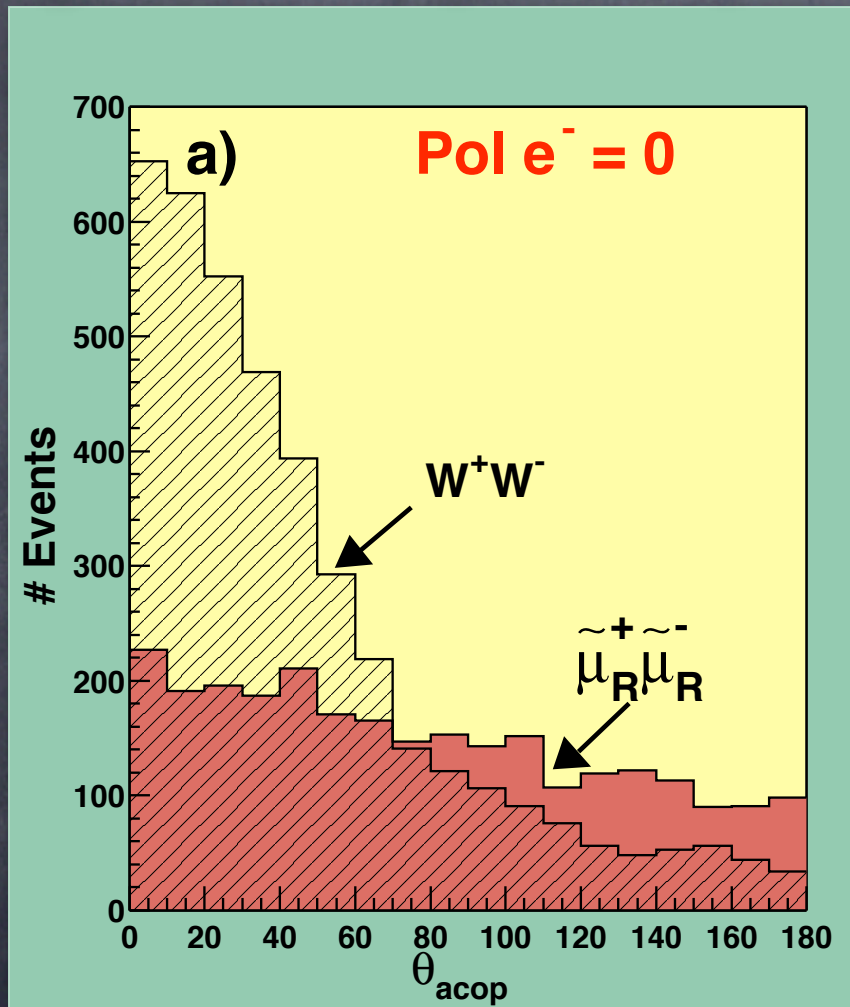

☉ We can get a very clean sample!

Mass Measurement

End Point Measurement

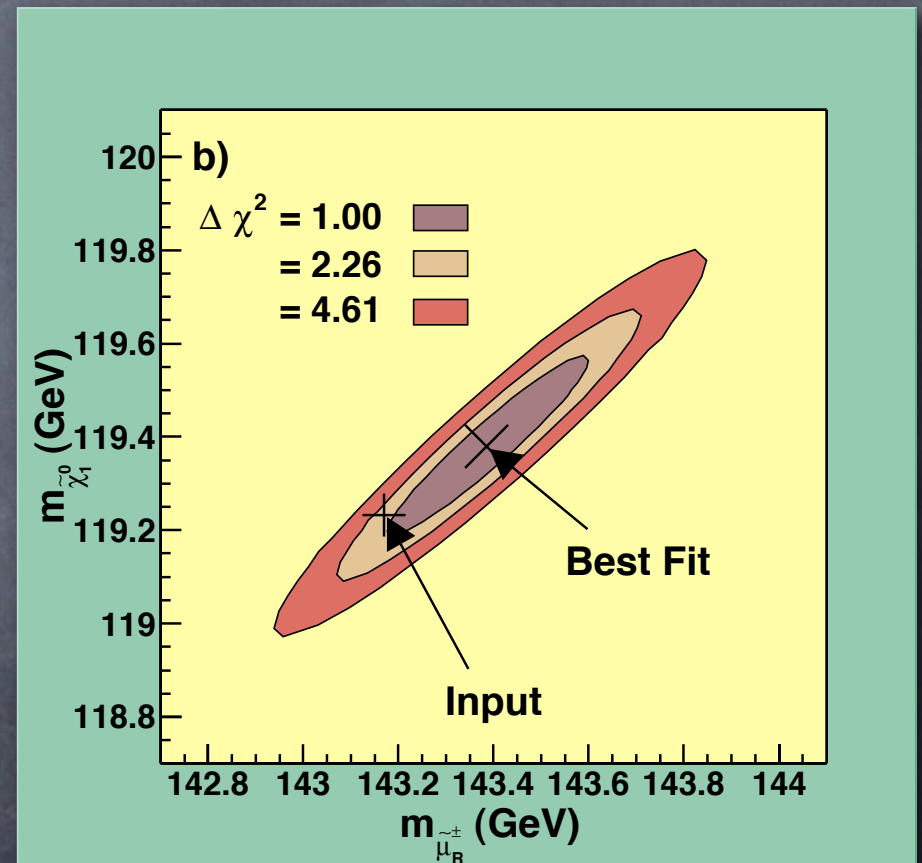
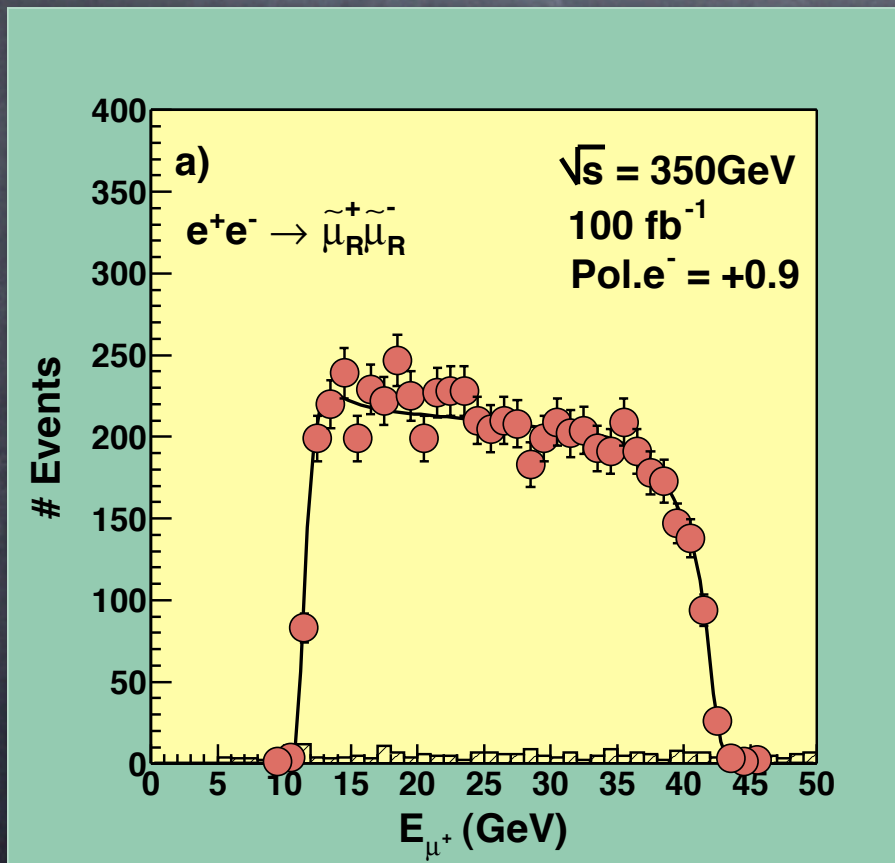
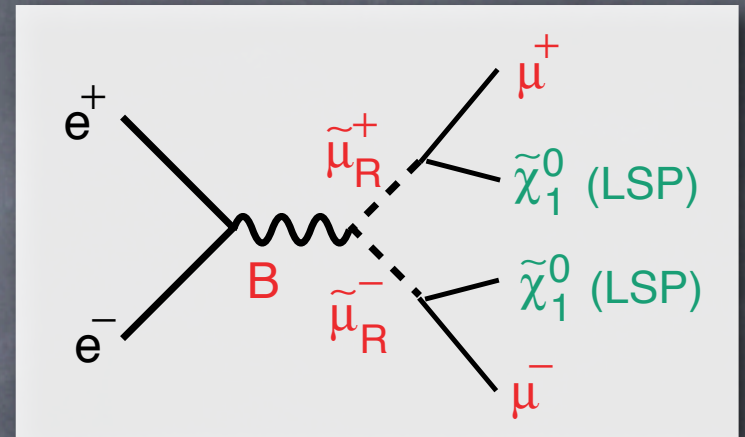

👁️ $O(0.1\%)$ measurement is possible!

Smuon Spin Measurement

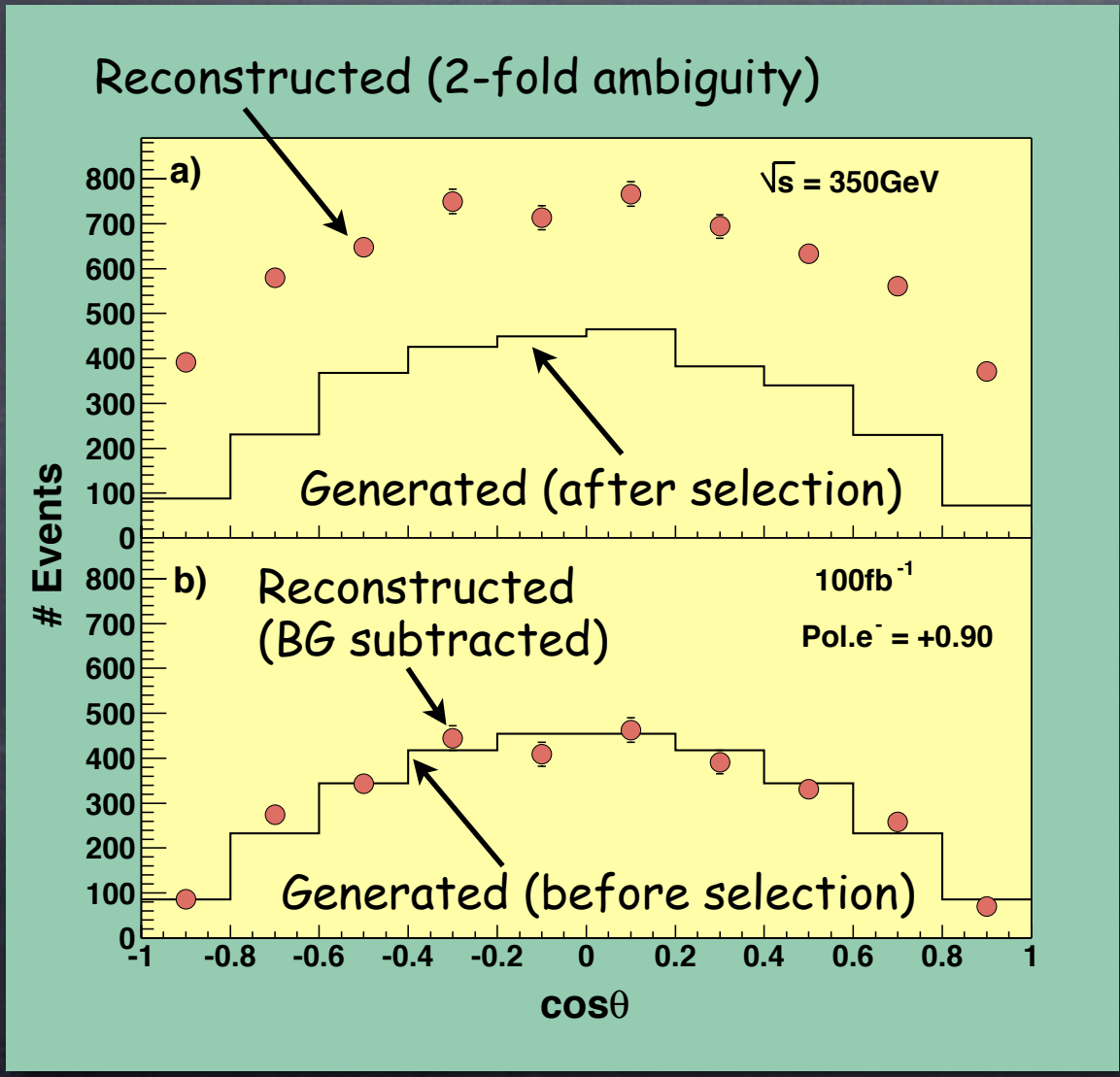

- 2-fold ambiguity
- wrong solution makes a flat BG
- easy to subtract
- For $J=0$ (P-wave)

$$\frac{d\sigma}{d\cos\theta} \propto \sin^2\theta$$

Chargino Studies

Mass Measurement

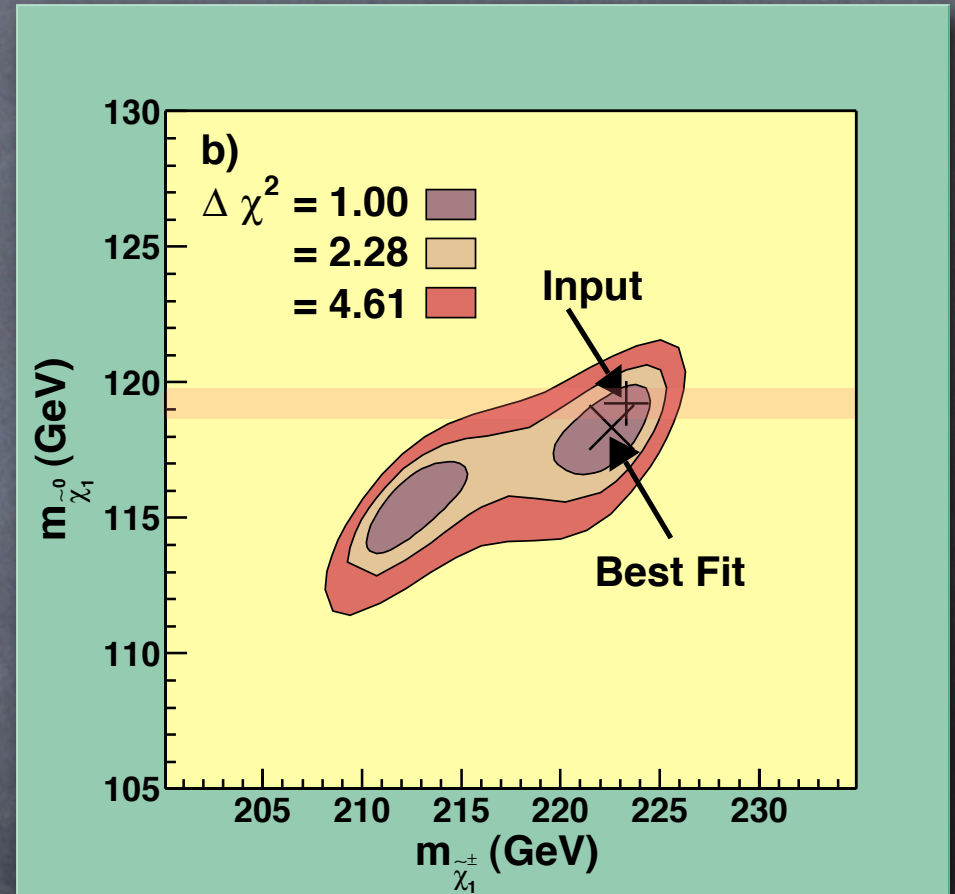
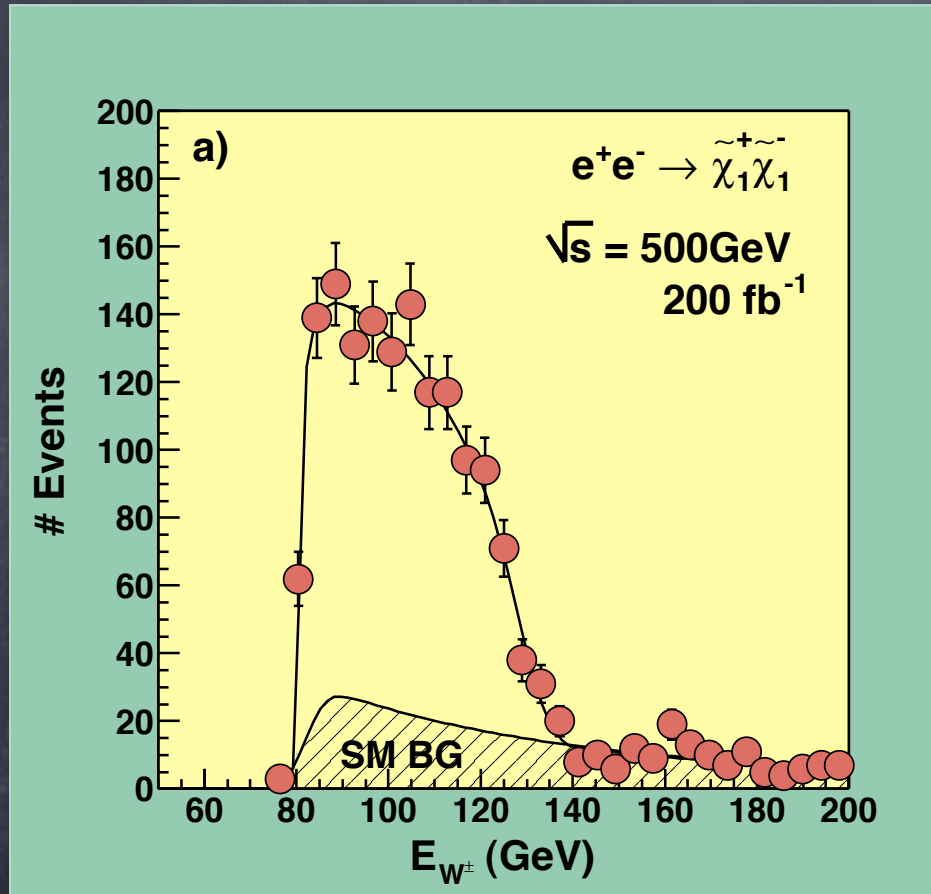

- $O(1\%)$ measurement is possible!
- Need good energy flow resolution

Test of GUT Relation

Global Fit

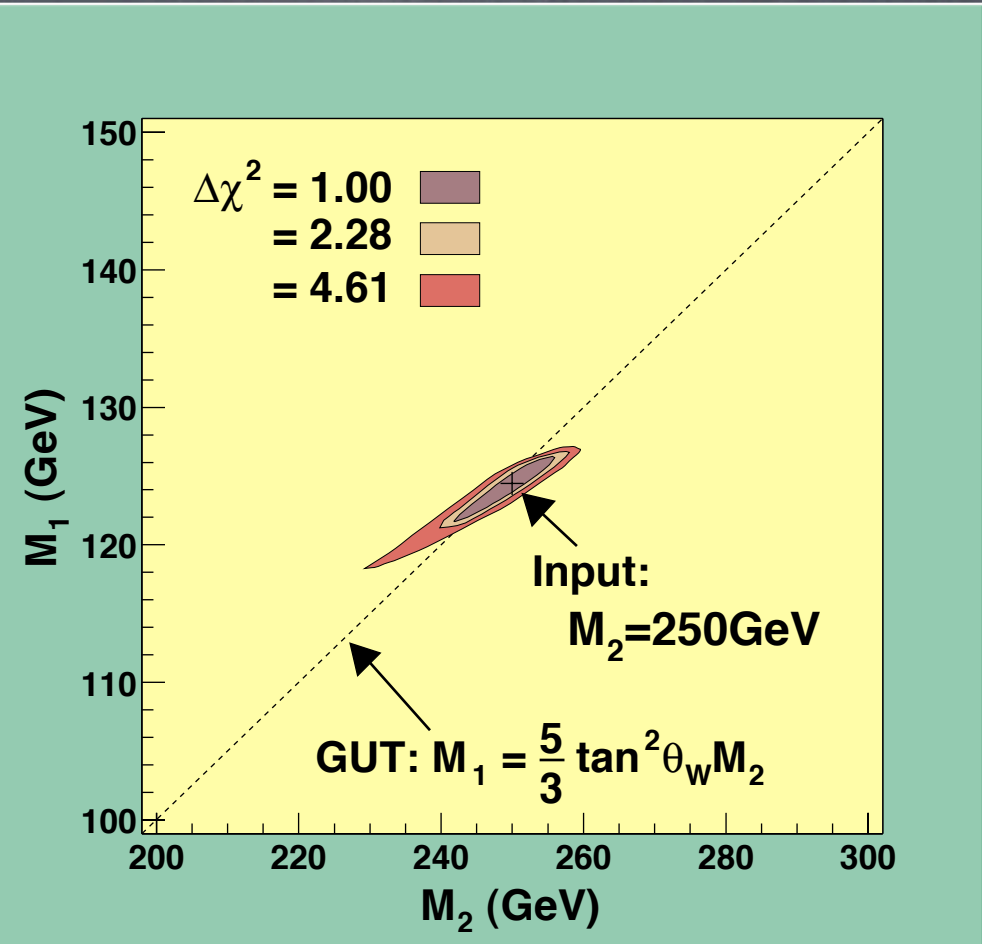
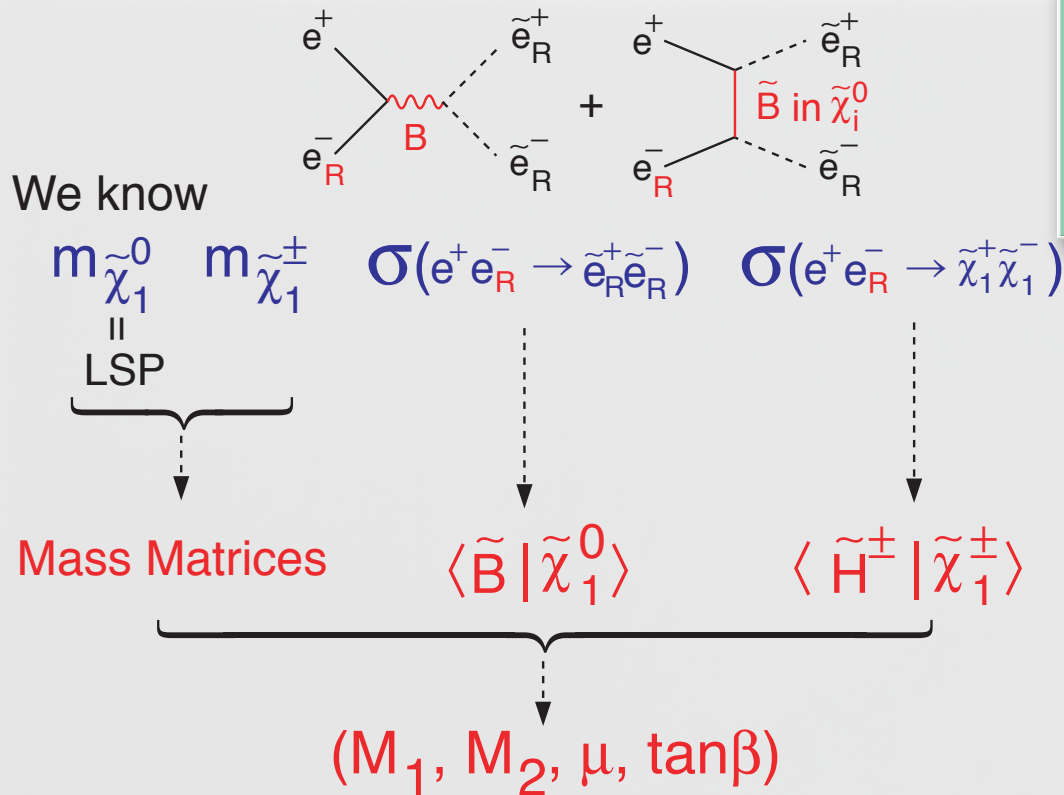

Discriminates AMSB

Beam Polarization
Essential!

Quantitative Test of SUSY

Nojiri-KF-Tsukamoto

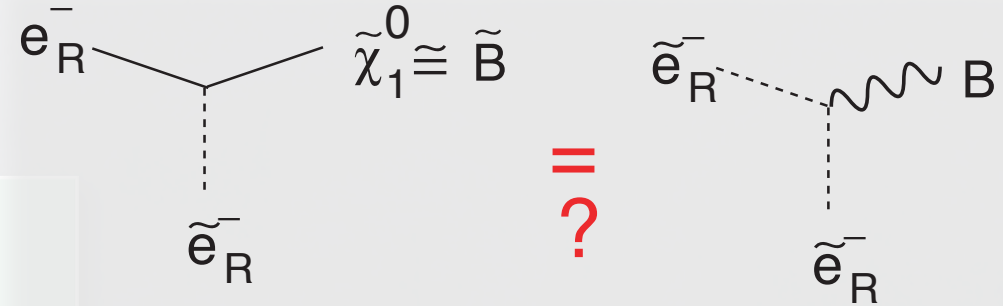
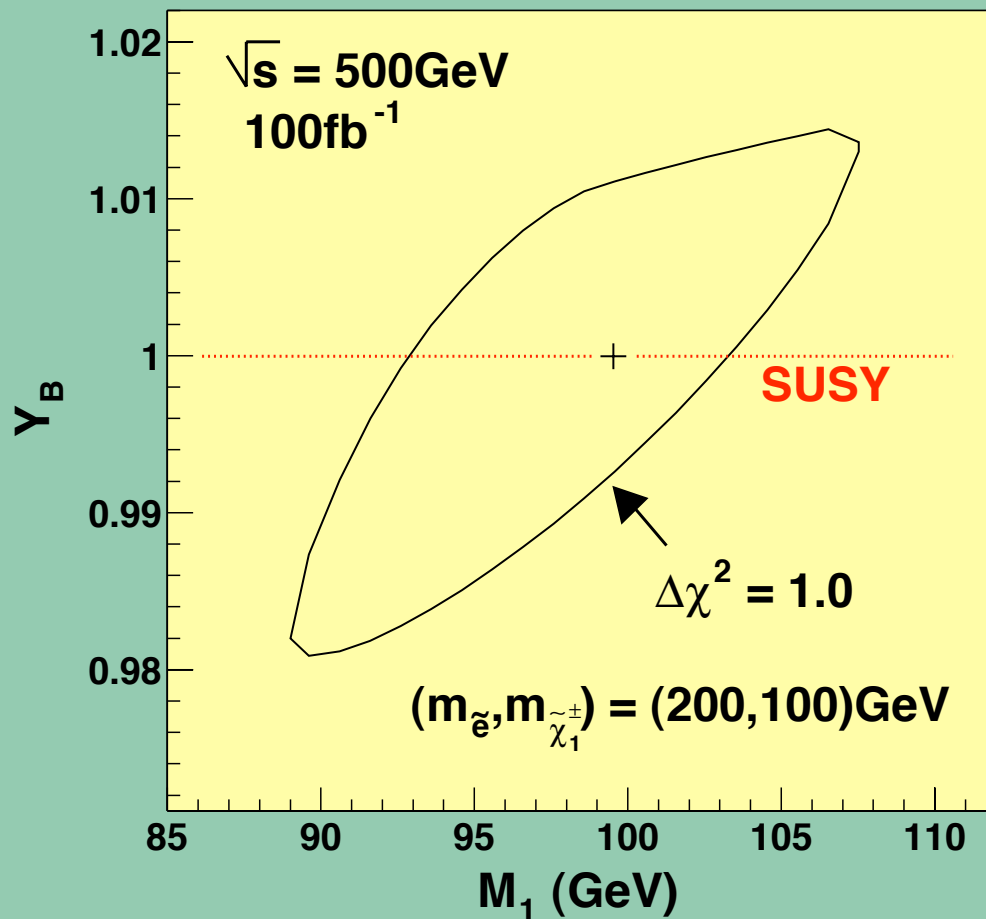

$$\left\{ \begin{array}{l} d\sigma \cong d\sigma(m_{\tilde{e}^\pm}, m_{\tilde{\chi}_1^0}, g'_\chi) \\ E_e \text{ distribution (Endpoints)} \end{array} \right.$$

$O(1\%)$ Test of SUSY
is possible!

Cosmological Connection

Cold Dark Matter = LSP?

WMAP/Planck v.s. LHC/ILC

J.Feng 2005

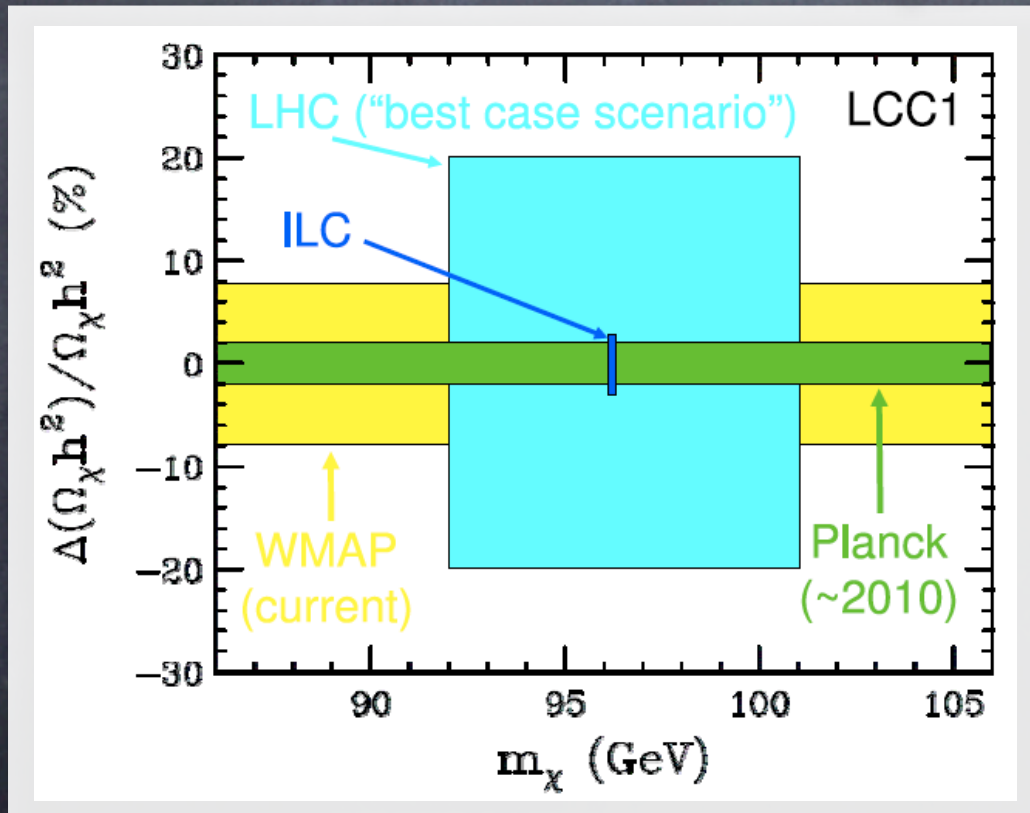

WMAP

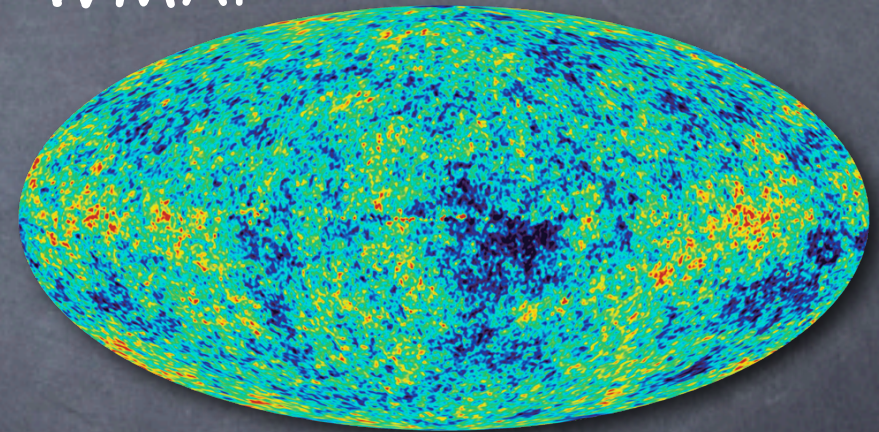

Nasa/WMAP Science Team

$$\Omega_\chi h^2 = 0.113 \pm 0.009$$



Comparison of CMB and LHC/ILC will answer this !

Large Extra Dimensions

Brane World Scenario

Our World = Brane

All the SM particles live on the brane!

Gravitons live in the bulk!
--> may leave the brane and disappear from our world!

SM particles

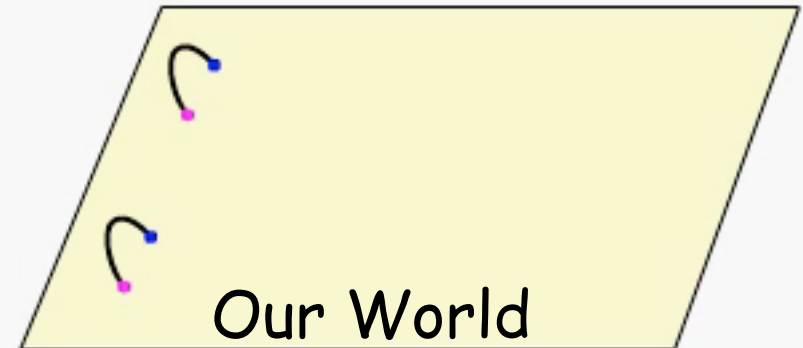

Gravitons

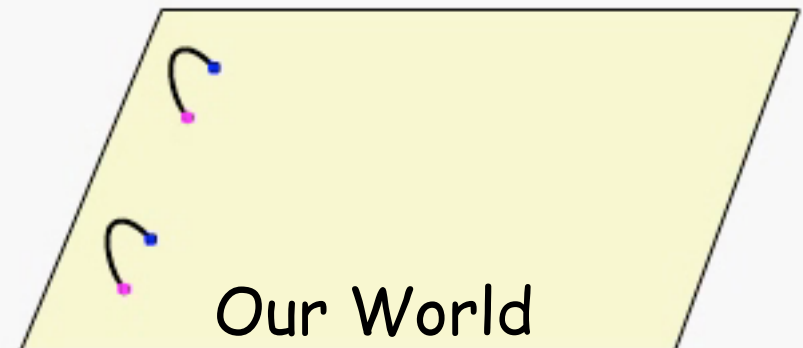

Large Extra Dimensions

- How to Tell LED Signals from Others?
- How to Decide Nature of Extra Dimensions?
 - Size and Shape (Topology)?
 - Non-commutative Geometry?
- Possible Probes
 - Quantum Gravity Effects (KK Modes)?
 - Brane Excitation (KK Modes of SM particles)?
 - Classical Gravity Effects (Black Holes)?
 - Stringy Effects (Regge, Winding Modes)?

Large Extra Dimensions

- How to Tell LED Signals from Others?
 - How to Decide Nature of Extra Dimensions?
 - Size and Shape (Topology)?
 - Non-commutative Geometry?
 - Possible Probes
 - Quantum Gravity Effects (KK Modes)?
 - Brane Excitation (KK Modes of SM particles)?
 - Classical Gravity Effects (Black Holes)?
 - Stringy Effects (Regge, Winding Modes)?

Large Extra Dimensions

- How to Tell LED Signals from Others?
 - How to Decide Nature of Extra Dimensions?
 - Size and Shape (Topology)?
 - Non-commutative Geometry?
 - Possible Probes
 - Quantum Gravity Effects (KK Modes)?
 - Brane Excitation (KK Modes of SM particles)?
 - Classical Gravity Effects (Black Holes)?
 - Stringy Effects (Regge, Winding Modes)?

KK Interaction in 4-dim.

- (4+delta)-dim. Einstein's eq.

$$\square_{4+\delta} G_{MN} = -\frac{T_{MN}}{(M_{4+\delta})^{2+\delta}}$$

- Interaction Lagrangian

4-dim. reduction

$$\mathcal{L}_{int} = -\frac{1}{\bar{M}_P} \sum_{\vec{n}} \left(G_{\mu\nu}^{(\vec{n})} T^{\mu\nu} + H^{(\vec{n})} T^{\mu\mu} \right)$$

\vdots
 KK Gravitons

\vdots
 KK Gravi-scalars

$$T^{\mu\nu} = 2 \frac{\partial \mathcal{L}}{\partial g_{\mu\nu}} - g^{\mu\nu} \mathcal{L}$$

couple to everywhere in SM Lagrangian!

Typical LED Signal

Higgs Pair Production via KK Graviton Exchange

⦿ Impossible in SM

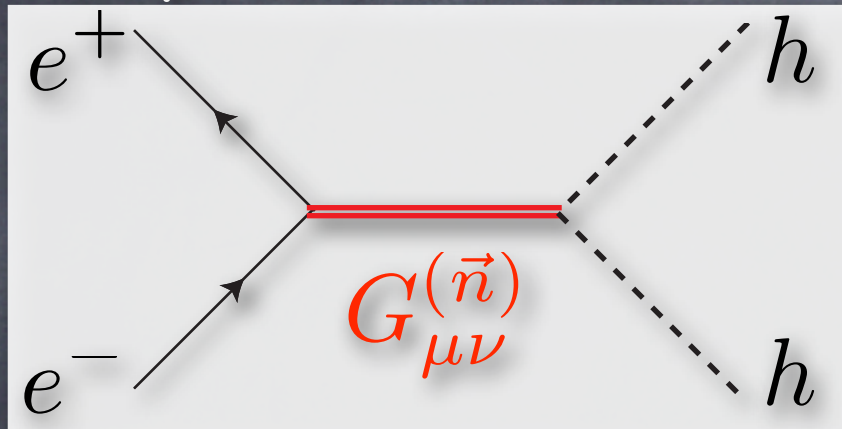

This is by no means a discovery channel of LED, but it is the cleanest way to test the $J=2$ nature of KK gravitons!

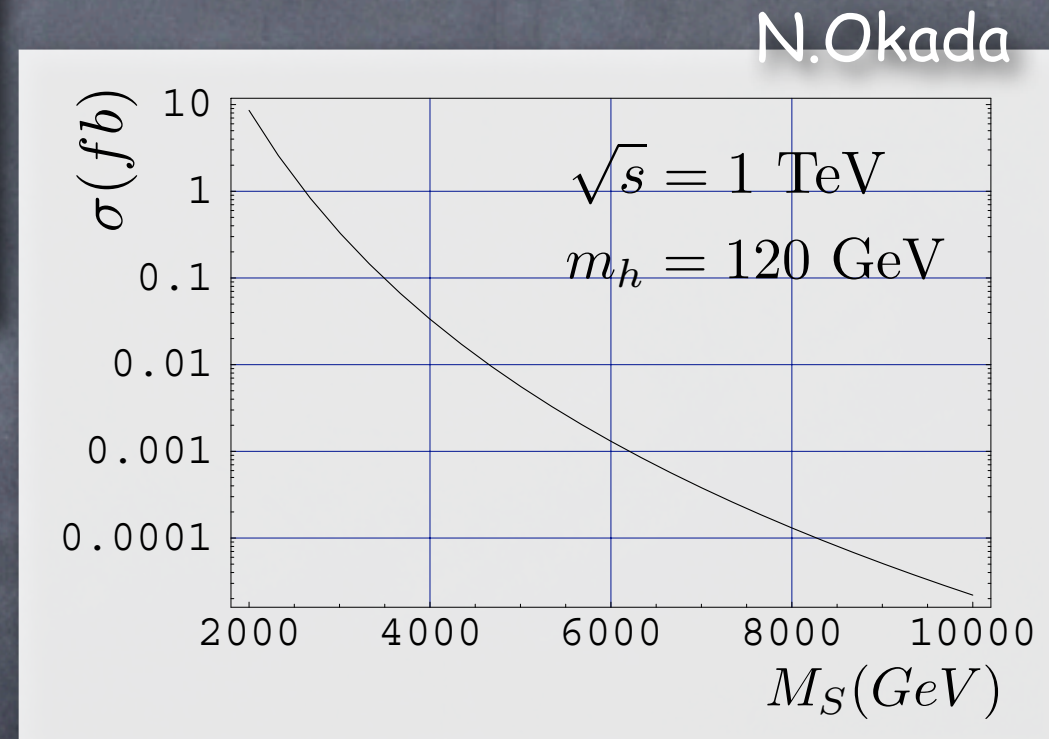

$$\sigma(e^+e^- \rightarrow hh) = \frac{\pi\lambda^2}{480M_S^8} \sqrt{1 - 4\frac{m_h^2}{s}} (s^3 - 8m_h^2s^2 + 16m_h^4s)$$

Angular Distribution

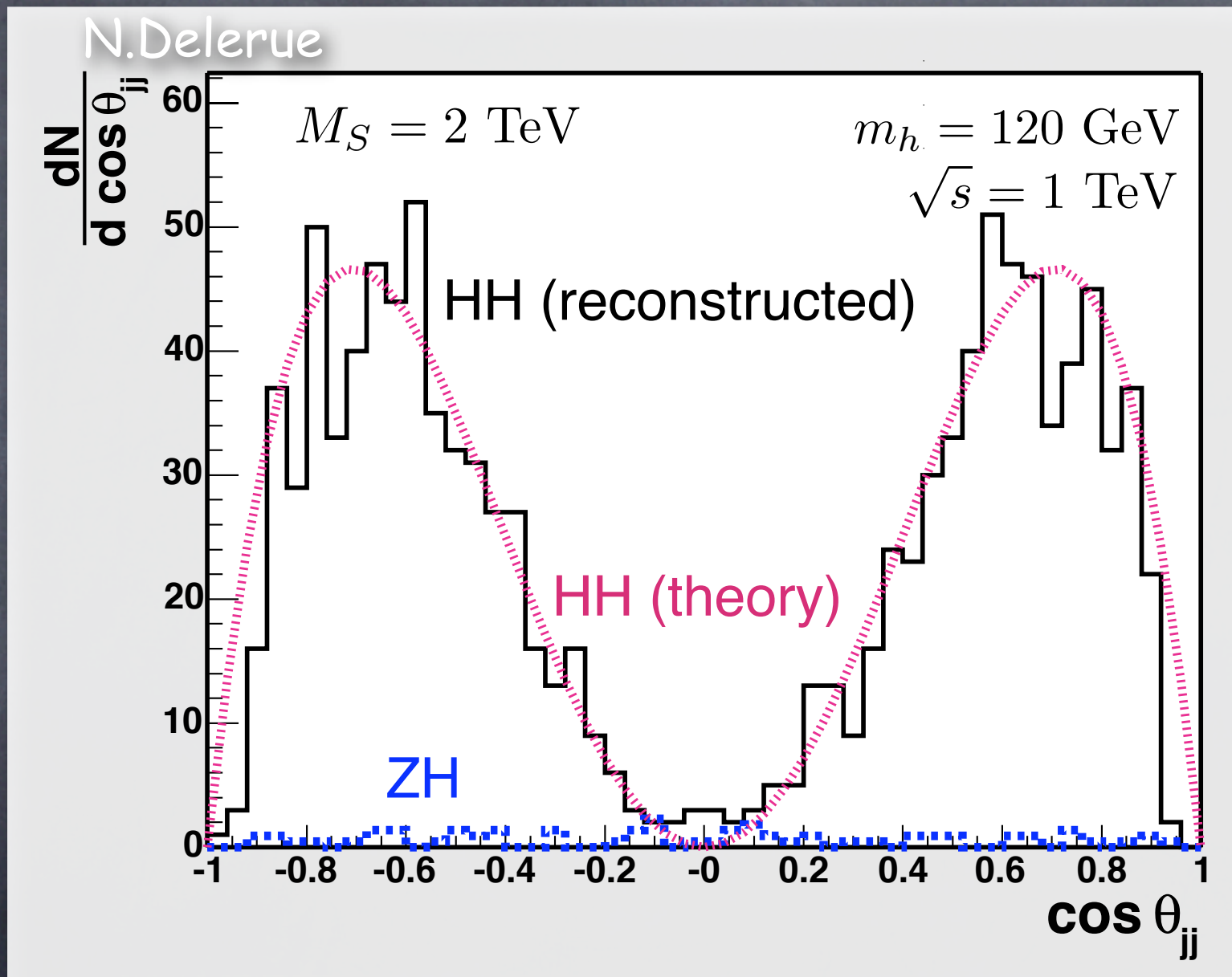

J=2 Nature of KK Gravitons

Size and Shape

KK Gravition Emission

Odagiri

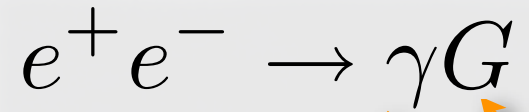
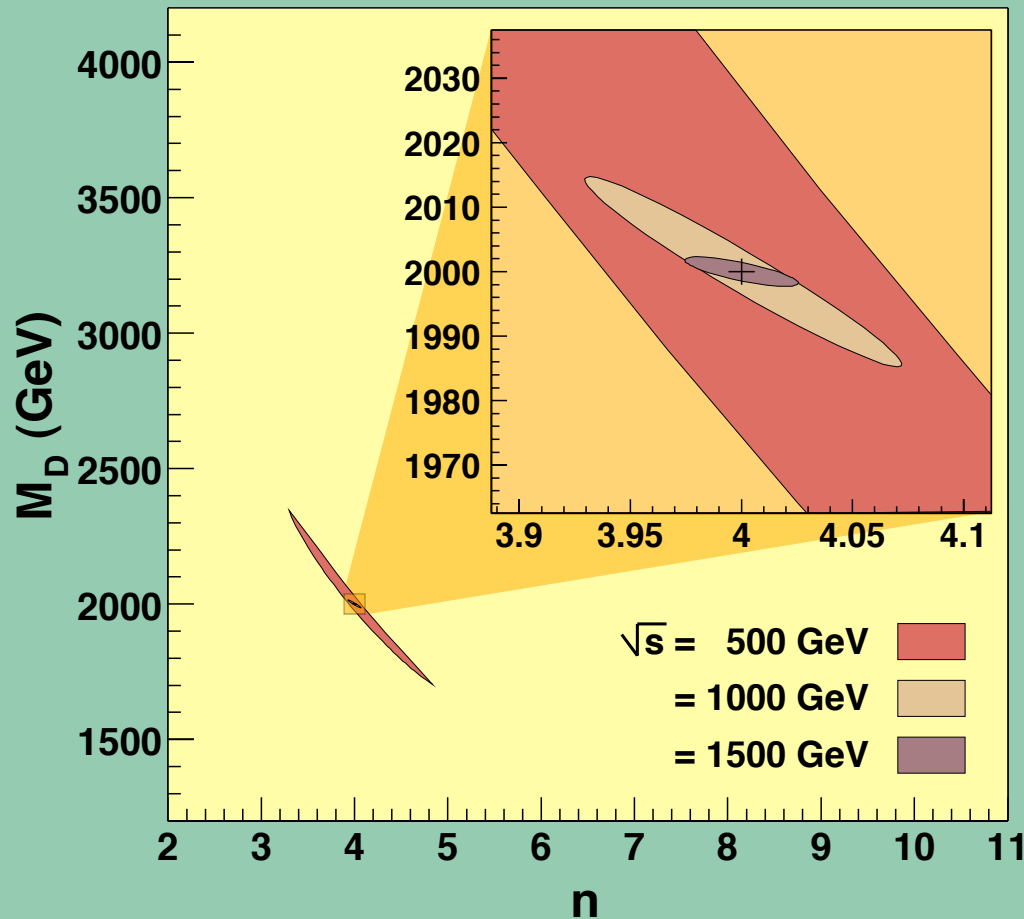

KK Gravitons
 \rightarrow Missing E

Single Photon Event

Angular Distribution

\rightarrow Spin of G ($J=2$ if KKG)

Energy Distribution

\rightarrow #extra dims. (n) and
 fundamental scale (M_D)

$$m_{Pl}^2 \sim M_D^{(2+n)} R^n$$

Extra Dimensions

A Lot More to Do

KKG can couple to any SM fields.

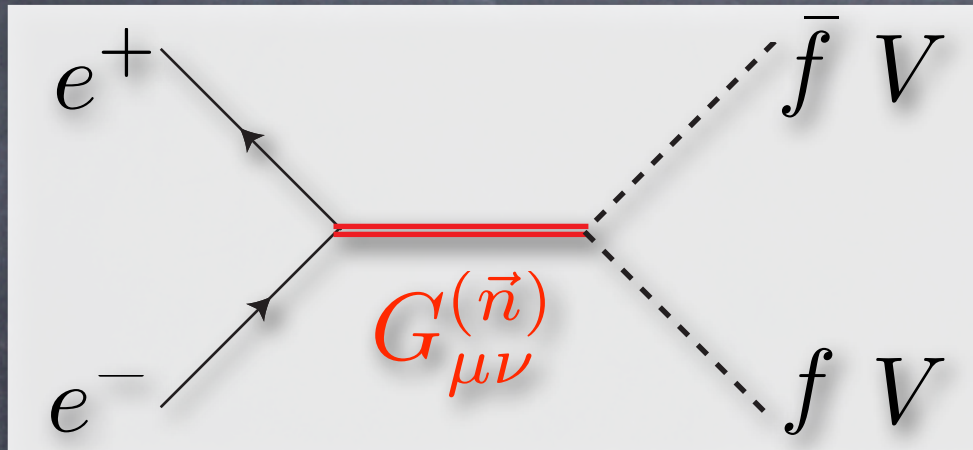

$$\mathcal{M} = \left(\frac{4\pi\lambda}{M_S^4} \right) T_{\mu\nu}(p_1, p_2) T^{\mu\nu}(p_3, p_4)$$

$$f = \mu, \tau, t, \dots$$

$$V = \gamma, Z, W, \dots$$

After all, we haven't answer most of the questions:

Brane Excitation?

Black Holes?

Stringy Effects?

Non-commutative Geometry?

Be Prepared for Unexpected

Is Our Detector Good Enough?

- Hermeticity
- Particle Flow Resolution
- Vertex Tagging
- Time Stamping
- Photon Vertex (Off-vertex Photon)
- Heavy Long-lived Particles?
- Polarization (e^+ ?, Transverse Pol.?)

LHC + LC or LHC x LC

Essentiality

- Higgs
 - Discovery --> LHC
 - Yukawa and Self Couplings --> LC
- Supersymmetry
 - Super Spectroscopy
 - Colored Sparticles --> LHC
 - Colorless Sparticles --> LC
- Large Extra Dimensions
 - Black Hole --> LHC
 - Size and Shape --> LC

Summary

- The test of the 2nd pillar of the SM (symmetry breaking and mass generation mechanism) is the most important and urgent problem to solve.
- The sub-TeV LC will be crucial to carry out this mission and hence we need it regardless of the BSM scenarios.
- To what extent the LC will be able to explore the BSM depends on its scale and thus luck.
- If its scale is not too high, we can do a lot:
 - precision super spectroscopy to test SSB mech.
 - measurement of size and shape of LED.